

# R&S® M3TR

## Software Defined Radios

### Multiband, multimode, multirole radio family for tactical communications



# Contents

<b>R&amp;S®M3TR Software Defined Radios</b> .....	4
A generation of high-performance digital radios.....	4
At a glance .....	5
<b>The three Ms</b> .....	6
Multiband .....	6
Multimode .....	7
Multirole .....	7
<b>R&amp;S®MR300xH/R&amp;S®MR300xU multiband tactical radio</b> .....	8
<b>R&amp;S®MR3000P tactical handheld transceiver</b> .....	9
<b>Configuration with external power amplifiers</b> .....	10
<b>Configuration overview of vehicle/command post station</b> .....	11
<b>Configuration overview of tactical radio</b> .....	12
<b>Configuration overview of handheld transceiver</b> .....	13
<b>Ease of operation</b> .....	14
<b>Software options</b> .....	16
EPM (ECCM) waveforms.....	17
ALE – automatic link establishment .....	19
<b>R&amp;S®MR300xH/R&amp;S®MR300xU supported services</b> .....	20
Voice communications .....	20
Data communications .....	22
<b>R&amp;S®M3TR supported services</b> .....	26
GPS services.....	26
BIT .....	27
Channel/net memory .....	28



<b>Accessories for the R&amp;S®MR300xH/</b>	
<b>R&amp;S®MR300xU</b> .....	29
Headset/handset/loudspeaker .....	29
Batteries and battery chargers .....	30
Antenna tuning unit and auxiliary equipment .....	31
Docking stations.....	32
Antenna selection chart – HF band .....	33
Antenna selection chart – VHF band.....	34
Antenna selection chart – VHF/UHF band .....	35
<b>Accessories for the R&amp;S®MR3000P tactical</b>	
<b>handheld transceiver</b> .....	36
<b>External amplifiers</b> .....	
Configuration overview with docking station and	
power amplifiers.....	37
<b>R&amp;S®VT3050 50 W VHF/UHF power amplifier</b> .....	38
<b>R&amp;S®VT3050C 50 W VHF/UHF compact</b>	
<b>power amplifier</b> .....	39
<b>R&amp;S®VK3150 150 W HF power amplifier</b> .....	40
<b>R&amp;S®VK3150C 150 W HF compact</b>	
<b>power amplifier</b> .....	41
<b>R&amp;S®MG3500 500 W HF power amplifier</b> .....	42
<b>R&amp;S®IV3001 power supply unit</b> .....	44
<b>R&amp;S®RNMS3000 radio network management</b>	
<b>system</b> .....	45
Utilization planning, radio network configuration and	
data distribution.....	45
<b>Product overview</b> .....	49

Note: Frequencies are rounded to full MHz for better reading.  
For detailed frequencies, see the respective data sheet.  
Some of the pictures show options.

# R&S®M3TR Software Defined Radios

## A generation of high-performance digital radios

### The challenge

Today's military missions are characterized by joint operations of multinational armed forces. Interoperability of the equipment, especially in the field of communications, is therefore the primary objective of the international partners responsible for creating one of the most important aspects for efficient cooperation. The R&S®M3TR features maximum flexibility in terms of frequency bands and waveforms for practically all services and platforms.

### The solution

The R&S®M3TR software defined radio family is a generation of high-performance digital radios. The heart of the integrated communications system is the lightweight R&S®MR300xH/R&S®MR300xU manpack radio, which offers solutions for all aspects of tactical communications as well as uniform and reduced interservice logistics. A lightweight handheld version (R&S®MR3000P) complements the radio family. Like the manpack radios, the R&S®MR3000P supports both open and secure communications modes.



R&S®MR300xH/R&S®MR300xU manpack radio.

# R&S®M3TR

## Software Defined Radios

### At a glance

#### Base units

- ▮ R&S®MR300xH multiband tactical radio
- ▮ R&S®MR300xU multiband tactical radio
- ▮ R&S®MR3000P VHF handheld transceiver

#### Key features

- ▮ Multiband capability
- ▮ Multiwaveform capability
- ▮ Software-configurable and upgradeable (P<sup>3</sup>I)
- ▮ Selective links in one net
- ▮ GPS reporting and message services
- ▮ User-friendly HMI (single-knob control for basic operation)

#### Logistics and readiness

- ▮ Minimum volume and weight
- ▮ Built-in test down to module level
- ▮ Common logistics concept for reduced costs throughout lifecycle
- ▮ Common human-machine interface (R&S®MR300xH/R&S®MR300xU)
- ▮ Automatic firmware update of external components
- ▮ Synthesizer calibration via antenna connector
- ▮ Minimum training required
- ▮ Excellent flexibility
- ▮ High MTBF
- ▮ Low volume and weight
- ▮ Power-saving mode



R&S®MR3000P handheld transceiver.

# The three Ms

# Multiband

For applications using various services and networks, different types of radio units were previously required. The R&S®M3TR covers the entire spectrum from the HF via the VHF to the UHF band, allowing interoperability as well as uniform and reduced interservice logistics. The frequency flexibility of the R&S®M3TR meets various national and international regulations, providing global operation in fast-changing missions and environments.

## Multiband tactical radio family

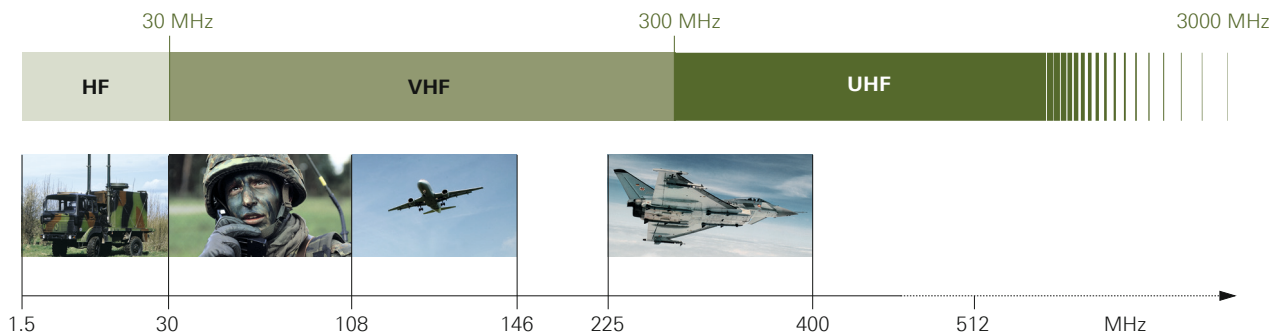

**R&S®M3TR vehicular station** 1.5 MHz to 512 MHz:  
R&S®MR300xH/R&S®MR300xU with external power amplifiers



**VHF/UHF manpack** 25 MHz to 512 MHz:  
R&S®MR300xU



**HF/VHF manpack** 1.5 MHz to 108 MHz: R&S®MR300xH



**VHF handheld** 25 MHz to 146 MHz:  
R&S®MR3000P



# Multimode

A software radio not only offers flexible network solutions, it also integrates existing national or company standards into a single unit. Due to optimized protocols and waveforms, the R&S®MR300xH/R&S®MR300xU attains maximum throughput rates for digital voice, data and position location.

## Available waveforms

### BLOS

- 2nd generation (2G) ALE in line with FED-STD-1045/46/49
- 3rd generation (3G) ALE in line with STANAG 4538
- EPM (ECCM) in line with R&S®SECOM-H, full interoperability with R&S®M3SR Series4100
- Modem waveforms in line with
  - STANAG 4285
  - STANAG 4529
  - STANAG 4539
  - STANAG 4415
- FF modulation in line with
  - AM, FM, SSB

### LOS

- EPM (ECCM) in line with
  - R&S®SECOM-V
  - R&S®SECOM-P, full interoperability with R&S®MR3000P
  - R&S®SECOS 5/16 TDMA, full interoperability with R&S®M3AR, R&S®M3SR Series4400
  - HAVE QUICK I/II
- Modem waveforms
  - VHF/UHF modem, up to 72 000 bit/s

### Security

- Embedded COMSEC, 256-bit key
- Interface for various external COMSEC devices

### Digital voice

- Vocoder adapted to mode of operation and bandwidth

# Multirole

The multirole features of a software defined radio are mainly determined by its ease of integration into tactical communications networks. In addition to its use as a functional terminal in the individual subnet, e.g. CNR or PRN, it can also act as an interface between the various subnets. The R&S®M3TR can be used on diverse platforms and features interfaces to fixed networks such as WAN and LAN, as well as intelligent gateway and relay/rebroadcast functions such as routing of selective calls for subscribers inside/outside the home network.

# R&S®MR300xH/ R&S®MR300xU multiband tactical radio

## Brief description

The R&S®MR300x radios form a family of high-performance digital radios covering the HF, VHF and UHF bands. Owing to different high-speed data modes and protocols as well as different antijam modes for HF, VHF and UHF, they perfectly integrate into tactical communications networks.

The radios are software-configurable and reprogrammable, including preplanned product improvement (P<sup>3</sup>I). Man-packs of the R&S®M3TR family are based on one mechanical platform, with a common logistics concept and one human-machine interface (HMI).

## Key features

- ▮ Software-configurable and upgradeable (P<sup>3</sup>I)
- ▮ Multiband capability (1.5 MHz to 512 MHz with external devices)
- ▮ Multiwaveform capability (HF house, VHF/UHF tactical and G-A-G waveforms)
- ▮ Embedded EPM (ECCM) in line with R&S®SECOM and R&S®SECOS, HAVE QUICK I/II
- ▮ Selective links in one net
- ▮ Integrated GPS, position report
- ▮ Removable front panel for flexible use and integration
- ▮ User-friendly HMI
- ▮ High data rate of up to 72 000 bit/s
- ▮ IP over air capability (R&S®IPoA)
- ▮ SIP-based remote voice operation
- ▮ MTBF > 8000 hours





# R&S®MR3000P

## tactical handheld transceiver

### Brief description

The R&S®MR3000P is a small, lightweight, handheld transceiver that perfectly complements the R&S®M3TR family. Though compact, the R&S®MR3000P has all the features required of a tactical transceiver. It provides reliable connections, even in topographically difficult terrain, and is suitable for flexible integration into tactical networks. Since the transceiver can interoperate with the R&S®M3TR, it enables continuous radiocommunications both within and between forces. The expanded frequency range of the handheld transceiver also supports interoperability. It covers not only tactical VHF but also parts of the HF and VHF air traffic control bands.

Due to its jam-resistant digital waveform with embedded software encryption (R&S®SECOM-P), the R&S®MR3000P provides high-quality connections. Moreover, its transmit power of up to 5 W allows high ranges, even in difficult terrain. For network planning and configuration purposes, established tools such as R&S®RNMS3000 can be used. Seamless integration into tactical networks with fixed and vehicle stations as well as highly mobile forces is possible without any problem. The R&S®MR3000P features an integrated crypto module of the highest security level to provide protection for confidential messages.

### Key features





- Multiband capability (25 MHz to 146 MHz)
- Embedded EPM (ECCM) in line with R&S®SECOM-P
- 5 W RF output power
- Secure transmission of voice, data and short messages
- Selective call with sender authentication
- Interoperability with the R&S®M3TR family
- GPS position report
- MTBF > 10 000 hours



# Configuration with external power amplifiers

The R&S®M3TR is designed to provide exceptional flexibility for networking services via RF networks on air. The radios can be used in portable, vehicular and stationary applications including installations in movable containers and shelters. Their rugged hardware complies with the individual MIL-STDs dealing with environmental conditions. Shockmounts are provided for mobile use.

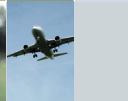
A wide range of antennas adapted to the various applications (portable, mobile, base station) is available. Radio functions can be remote-controlled by means of an RC unit.

Covered frequency ranges and RF power for different configurations			HF	Tactical VHF	ATC	Air defense			
									
Frequency in MHz			1.5	30	108	146	225	400	512
Amplifier	R&S®VK3150C, R&S®VK3150 or R&S®MG3500	R&S®VT3050C or R&S®VT3050							
Man-pack radio									
R&S®MR300xH			20 W	10 W	RX				
R&S®MR300xH	•		150 W	10 W	RX				
R&S®MR300xH		•	20 W				50 W		
R&S®MR300xH	•	•	150 W				50 W		
R&S®MR300xU			RX				10 W		
R&S®MR300xU	•		150 W				10 W		
R&S®MR300xU		•	RX				50 W		
R&S®MR300xU	•	•	150 W				50 W		

# Configuration overview of vehicle/command post station

This example of a radio station consists of the manpack radio with audio and data accessories, and two power amplifiers. Amplifiers are available as compact versions or as standalone units. A compact amplifier (R&S®VT3050C or R&S®VK3150C) also includes the frame for mechanically fastening a radio in a vehicular installation and can be equipped with options for connecting external audio distribution systems or field telephones. Standalone amplifiers are connected to a compact amplifier to further increase the usable frequency range of the system. Amplifiers increase output power up to 50 W in the VHF and UHF bands and up to 150 W or 500 W in the HF band.

If these power amplifiers are used, a single R&S®M3TR radio (R&S®MR300xH or R&S®MR300xU) spans the entire frequency range from 1.5 MHz to 512 MHz without any gaps.

**Audio/data accessories**

- Handsets/headsets
- Speakers
- Vehicle intercom
- Radio wire integration



**VHF/UHF antennas**

- VHF
- UHF
- Multiband



**HF antennas**

- Whip
- Wire
- NVIS



**R&S®VT3050C VHF/UHF compact amplifier or R&S®VK3150C HF compact amplifier**



**R&S®VK3150 HF power amplifier or R&S®VT3050 VHF/UHF power amplifier**



**R&S®FK3150 antenna tuning unit**



**Remote control**

- RC units
- RC software



**Data transmission/networking**

- Tactical PC/PDA
- Message handling software
- Blue force tracking



**Mission planning**

- Fillguns
- Mission planner software
- Remote device loader software
- Remote distributor software



# Configuration overview of tactical radio

## Audio accessories

- R&S®GA3001 handset with PTT
- R&S®GA3002 headset with PTT
- R&S®GA3003 microphone/speaker
- R&S®GA3005 loudspeaker



## Chargers and batteries

- R&S®IC3001 battery charger, DC
- R&S®IC3000 battery charger, AC
- R&S®IB3001/3002 battery pack



## Data communications

- Tactical notepad, with application software
- Cables, e.g. R&S®GK3024 data/remote cable



## R&S®MR300xH/R&S®MR300xU tactical radio



### Software options:

- R&S®GS3001S R&S®SECOM-H
- R&S®GS3006S HAVE QUICK I/II
- R&S®GS3030S R&S®SECOM-VI-P
- R&S®GS3516S R&S®SECOS 5/16 TDMA
- R&S®GS4101S ALE 2G
- R&S®GS4155S ALE 2G, ALE 3G, STANAG 4538
- R&S®GM4120S HF modem STANAG 4285, STANAG 4529, STANAG 4539, STANAG 4415
- R&S®GM4121S secure voice/data

## Radio configuration

- R&S®KGE3000 key generation equipment for R&S®SECOM
- R&S®KDD3750 key distribution device for R&S®SECOS 5/16 TDMA
- R&S®GP3000 fillgun for all relevant pre-set information and R&S®SECOM keys
- R&S®GP3100 fillgun for HAVE QUICK I/II



## Other accessories

- R&S®MZ3088 rucksack
- R&S®GK3005 connecting cable
- R&S®GK3009 power supply cable



## Manpack antennas

- R&S®AK3001 wire antenna
- R&S®AK3031 wire dipole antenna
- R&S®HD3001 long wire antenna
- R&S®HD3088 hang-up antenna
- R&S®HV3003 GPS antenna
- R&S®HV3004 whip antenna
- R&S®HV3007 whip antenna
- R&S®HV3009 whip antenna
- R&S®HV3020 whip antenna



# Configuration overview of handheld transceiver

## Radio configuration

- ▮ R&S®GP3021 fillgun
- ▮ R&S®CS3021 central update tool



## R&S®MR3000P handheld transceiver



## Chargers and batteries

- ▮ R&S®IB3022 battery pack, Li-ion
- ▮ R&S®IC3023 vehicle charger, DC
- ▮ R&S®IC3022 charger, AC, for up to eight batteries
- ▮ R&S®IC3024 charger, AC, for one battery



## Audio accessories

- ▮ R&S®GA3023 microphone/loudspeaker
- ▮ R&S®GA3022 headset



## Other accessories

- ▮ R&S®MZ3021 bag
- ▮ R&S®MZ3022 set bag
- ▮ R&S®IV3021 vehicle support



## Handheld antennas

- ▮ R&S®HV3031 GPS receiver
- ▮ R&S®HV3022 short tape antenna
- ▮ R&S®HV3021 long tape antenna
- ▮ R&S®HV3088L long tape antenna



# Ease of operation

The R&S®M3TR radios offer many diverse functions that help ensure straightforward, secure and error-free operation.

The functions are available via hierarchically structured menus and context-sensitive softkeys. The clever concept and the arrangement of the control elements allow intuitive control of the radio even under difficult conditions from outside and without having the removable front panel in view.

## Operation of the R&S®MR300xH/R&S®MR300xU

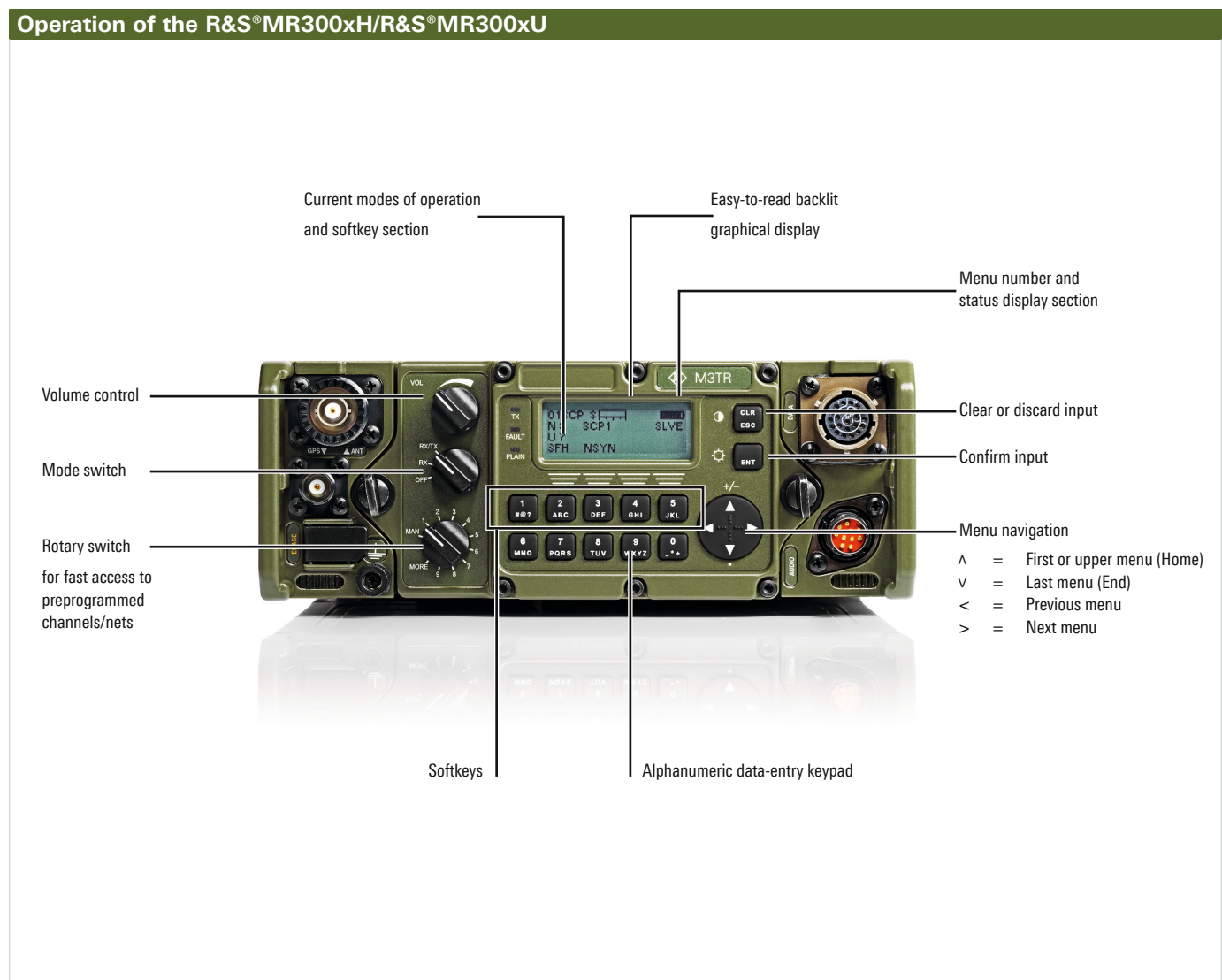

### Menu-oriented user interface and PC-based tools

The R&S®MR300xH/R&S®MR300xU user interface is menu-oriented and easy to use. Its eleven-step rotary switch for the operating mode allows direct access to the nine most often used modes (nets) of the radio. These modes contain the complete setting of parameters such as the transmit power, the hailing frequency, the link mode, the EPM (ECCM) procedure and other net-specific adjustments. These preset pages are conveniently prepared with a PC or at a central location using the R&S®RNMS3000 radio net management software, and are loaded into the radio over the data connector before a mission starts.

### Convenient and easy link establishment

Link establishment is convenient and easy. The operator chooses a mode (position 1 to 9 of the rotary switch) and activates the push-to-talk key or data transmission mode on the terminal. Everything else is done automatically. Two additional positions are available: MAN to use the radio in manual mode for fixed-frequency operation and MORE to access up to 90 additional preset pages via the radio keypad.



# Software options

As a software defined radio, the R&S®M3TR is able to run a wide variety of waveforms. To provide radio systems that perfectly fit customer needs and applications, radio software can be ordered on the basis of communications requirements.

Upgrades by adding new waveforms or extending the frequency range of radio networks are also possible in this concept. Communications networks can therefore be tailored to always find the best compromise between current communications needs and budgetary setup.

EPM (ECCM) waveforms						
Type	Designation	Runs in frequency range (in MHz)	Support of waveform by			
			R&S®MR3000H/ R&S®MR3000U	R&S®MR3001H/ R&S®MR3001U	R&S®MR3002H/ R&S®MR3002U	R&S®MR3003H/ R&S®MR3003U
R&S®GS3001S	R&S®SECOM-H	1.5 to 30	•	•	•	•
R&S®GS3030S	R&S®SECOM-V	30 to 108/ 121 to 512	•	•	•	•
R&S®GS3030S	R&S®SECOM-P	30 to 88	•	•	•	•
R&S®GS3006S	HAVE QUICK I/II	225 to 400		•		•
R&S®GS3516S	R&S®SECOS 5/16 TDMA	225 to 400		•		•
R&S®GM4121S	Secure voice/data	1.5 to 108			•	•

ALE – automatic link establishment						
Type	Designation	Runs in frequency range (in MHz)	Support of waveform by			
			R&S®MR3000H/ R&S®MR3000U	R&S®MR3001H/ R&S®MR3001U	R&S®MR3002H/ R&S®MR3002U	R&S®MR3003H/ R&S®MR3003U
R&S®GS4101S	ALE 2G, FED-STD-1045/46/49	1.5 to 30			•	•
R&S®GS4155S	ALE 2G, FED-STD-1045/46/49 ALE 3G, STANAG 4538 (FLSU, LP, LDL, HDL, xDL, OD, ALM)	1.5 to 30			•	•

Modem waveforms						
Type	Designation	Runs in frequency range (in MHz)	Support of waveform by			
			R&S®MR3000H/ R&S®MR3000U	R&S®MR3001H/ R&S®MR3001U	R&S®MR3002H/ R&S®MR3002U	R&S®MR3003H/ R&S®MR3003U
R&S®GM4120S	HF modem STANAG 4285, STANAG 4529, STANAG 4539, STANAG 4415	1.5 to 30			•	•
R&S®GS3030S	VHF/UHF modem 72 000 bit/s	30 to 512	•	•	•	•



# EPM (ECCM) waveforms

## **R&S®SECOM-V and R&S®SECOM-H**

The R&S®SECOM waveform (R&S®SECOM-V for the VHF and UHF bands, R&S®SECOM-H for HF) with its high hop rates and secure synchronization is setting new standards. It ensures powerful protection against detection, interception, jamming and spoofing. User data (digital voice or data) is transmitted completely digitally and in encrypted form. Within one R&S®SECOM-V net, several subnets and sublinks can be established simultaneously in the point-to-point and point-to-multipoint modes. Network synchronization and access can be planned and controlled individually for each user. Methods such as late net entry or hailing (R&S®SECOM-V) are available for this purpose.

R&S®SECOM is a combination of COMSEC and TRANSEC for encrypted voice and data communications in the frequency-hopping mode.

The COMSEC part of the R&S®SECOM method is based on the R&S®RSCA crypto algorithm developed by Rohde&Schwarz. The method uses key lengths of up to 256 bit (approx.  $10^{77}$  variants). Assuming uninterrupted transmission, the same bit sequence would be repeated after about  $2 \times 10^9$  years. The keys required can be distributed by means of a key distribution device or directly from a PC. All keys are encrypted and the deciphered original is present only in the read-protected security processor. Crypto units complying with NATO standards such as ELCRODAT 4-2/R&S®MMC3000 may be used as an external option.

To plan communications networks and links, a PC-based radio network management system is available. This tool allows users to generate keysets, plan frequency resources, define user channels and services and set up complete networks of radios. After the desired networks have been defined, the resulting data can be easily distributed to the radios by means of a fillgun or directly by using one of the radios' data interfaces.

## **R&S®SECOM-V (R&S®GS3030S)**

R&S®SECOM is optimized for tactical communications and operates in the full VHF/UHF band. It is implemented as a software option running on all R&S®MR300xH/R&S®MR300xU tactical radios.

R&S®SECOM-V was developed to meet as closely as possible the network demands of the primarily land-based mobile users of tactical radio services. R&S®SECOM-V is attuned to the requirements of land forces, where the implementation and management of complex network structures are in the foreground. The primarily hierarchical command structure of the armed forces should be mapped as closely as possible to the communications network. To this end, users can be organized in networks using the same frequency pool and the same key – one each for TRANSEC and COMSEC.

Possible address modes are point-to-point, point-to-multipoint and broadcast. Network synchronization and access can be controlled by each user. Late net entry is available for this purpose.

## **R&S®SECOM-V automatic net entry and time beacon**

The radio automatically performs a net entry whenever synchronization is lost (R&S®M300xU/R&S®M300xH display message: NSYN). The time reference unit of an R&S®SECOM-V net automatically takes care of maintaining synchronization before it is lost. If the time beacon function is not active, a net entry may need to be performed from time to time.

## **R&S®SECOM-V out-of-band hailing**

Out-of-band hailing is an outstanding feature that considerably enhances the multiband capabilities of the R&S®M3TR radio with cross-band hailing. The latest software release makes it possible to scan FF calls over the entire frequency range from 1.5 MHz to 512 MHz. This means real multiband operation, as even HF calls can be received while operating the radio in the VHF/UHF range. All FF modulation and squelch modes for the detection of signals are supported.

### **R&S®SECOM-H (R&S®GS3001S)**

R&S®SECOM-H is a Rohde&Schwarz proprietary frequency-hopping HF radiocommunications waveform. R&S®SECOM-H is based on a multiwaveform concept and is designed to operate in environments where a certain percentage of the hop set frequencies are blocked due to either intentional disturbances (i.e. jamming) or unintentional ones, as well as environments experiencing severe Doppler spread and/or multipath delay. It is furthermore based on modem waveforms that can be adapted to the specific characteristics of the HF channel and its propagation.

R&S®SECOM-H provides digital voice (low bit rate vocoder at 600 bit/s, 1200 bit/s or 2400 bit/s, adjustable) and data services (up to 2400 bit/s). To ensure reliable links even in severely degraded channels, free hop set search (FHS) is available. FHS is an algorithm for the automatic adaptation of hop sets (ALE-like) based on channel evaluation. Radios in a point-to-point link will generate and use an advanced hop set containing only frequencies that have proven good HF performance. Channels are evaluated by measuring S/N, and results are shared between radios in the link during a three-way handshake.

For network synchronization, either the master-slave process or GPS can be used as the network time source. GPS-based network time eliminates the need for manual net entry; all stations in the network remain synchronized as long as the GPS signal is received.

Note: To have sufficient output power on an R&S®MR300xU radio in R&S®SECOM-H mode, the R&S®VK3150(C) HF power amplifier and other system components are required.

### **R&S®SECOM-P (R&S®GS3030S)**

R&S®SECOM-P is the standard EPM (ECCM) method for the R&S®MR3000P handheld transceiver. It was especially optimized for use on small, lightweight terminal equipment. Even for this platform, R&S®SECOM-P offers maximum performance and battery operating time. Since R&S®SECOM-P can also be loaded into R&S®MR300xH/ R&S®MR300xU equipment as a software option, R&S®SECOM-P provides full interoperability between all R&S®MR300x radios in mixed networks.

### **R&S®SECOS 5/16 TDMA (R&S®GS3516S)**

The R&S®SECOS air-ground-air waveform provides interoperability in the EPM (ECCM) mode between the R&S®M3TR and the R&S®M3AR and R&S®M3SR Series4400 radios. Besides digital voice mode, data transmission with data rates of up to 16000 bit/s is supported. Both TDMA and non-TDMA modes are implemented. For details on R&S®SECOS implementation in the R&S®M3TR, see the related Technical Information (R&S®SECOS). Network synchronization for R&S®SECOS can be accomplished using the master-slave process via an external time source or by using GPS as the network time.

Note: To have sufficient output power on an R&S®MR3001H or R&S®MR3003H radio in R&S®SECOS mode, the R&S®VT3050 or R&S®VT3050C VHF/UHF power amplifier is required.

### **R&S®SECOS 5/16 TDMA guard receiver**

The guard receiver function monitors up to two channels in background mode. This allows operators who are occupied with R&S®SECOS voice or data traffic and receive an emergency call to transmit on one of these dedicated frequencies without having to use another radio.

### **HAVE QUICK I/II (R&S®GS3006S)**

The NATO ground-air-ground waveform HAVE QUICK I/II provides interoperability in the EPM (ECCM) mode between the R&S®M3TR, R&S®M3AR, R&S®M3SR Series4400 radios and various types of legacy equipment.

Note: To have sufficient output power on an R&S®MR3101H or R&S®MR3103H radio in HAVE QUICK I/II mode, the R&S®VT3050 or R&S®VT3050C VHF/UHF power amplifier is required.

# ALE – automatic link establishment

## **ALE 2G (R&S®GS4101S)**

The common basic protocol standard for ALE is FED-STD-1045/1046/1049, known as 2nd generation or 2G ALE. It uses non-synchronized scanning of channels, and it takes about several seconds to half a minute to repeatedly scan through an entire list of channels looking for calls.

## **ALE 2G/ALE 3G (R&S®GS4155S)**

The latest ALE standard uses accurate time synchronization via GPS-locked clocks or a time server to achieve faster and more dependable linking. It is generally known as 3rd generation or 3G ALE. Synchronization may reduce the calling time to achieve a link to less than 10 seconds. Although 3G ALE is better and more reliable, the existence of a large, installed base of 2G ALE radio systems and the wide availability of equipment have made 2G the baseline standard for global interoperability.

Links are set up over fast link setup (FLSU) and kept stable using link maintenance (LM). Users can choose between open or encrypted LSU. Occupancy detection (OD) prevents collisions in the network.

## **xDL protocols (R&S®GS4155S)**

The Rohde&Schwarz ALE 3G built-in xDL data link protocols are LDL and HDL. They offer acknowledged point-to-point delivery of datagrams over an already established HF link. Each protocol is optimized for different channel conditions and datagram sizes to enable high throughput in all communications scenarios. A good throughput can be achieved even under very challenging channel conditions below 0 dB SNR.

The low-latency data link protocol (LDL) is optimized for delivering small datagrams in all channel conditions and also longer datagrams in poor channel conditions. It supports a maximum data rate of approx. 300 bit/s.

The high-throughput data link protocol (HDL) is optimized for delivering large datagrams in medium to good channel conditions and supports a maximum data rate of approx. 3400 bit/s.

The R&S®GM4121S software can be used to additionally encrypt xDL transmitted data.

The Rohde&Schwarz IP over air (R&S®IPoA) interface provides transparent IP functionality over the xDL data link protocol. It can be used to set up communications systems that require a transparent connection of IP networks over HF radio links. IP-based applications – such as situational awareness or message handling systems – are enabled to exchange their data over such radio links. A standard IP interface allows a customer application to be easily and economically connected to the HF radiocommunications system.

Alternatively, xDL protocols can be used for serial data transfer over the RS-232-C interface.

Note: To run ALE on an R&S®MR300xU radio, the R&S®VK3150 power amplifier together with a docking station or the R&S®VK3150C compact power amplifier and accessories such as an antenna coupler are required.

# R&S®MR300xH/ R&S®MR300xU supported services Voice communications

## Analog voice

The following signal modulations are available:

- J3E (USB, LSB)
- A3E (AM)
- H3E (AM)
- F3E (FM)

## Squelch

The R&S®M3TR supports the following squelch types:

- Received signal strength indication (RSSI)
- 150 Hz tone squelch
- Signal squelch (CTCSS selective calling)
- Syllabic squelch (digital recognition of voice components in signal)

## Digital voice (optional)

For communications under the EPM (ECCM) methods R&S®SECOM-V, R&S®SECOM-H, R&S®SECOM-P and R&S®SECOS 5/16 TDMA, voice is transmitted in digital form. The following vocoders are available:

### R&S®SECOM-V (R&S®GS3030S)

- MELPe vocoder 2400 bit/s
- AMBE vocoder 2400/4800/9600/16000 bit/s
- CVSD vocoder 16000 bit/s

MELPe is the standard vocoder for R&S®SECOM waveforms. It offers the best voice quality and is extremely insensitive to background noise. Due to their favorable characteristics, MELPe vocoders were also a preferred choice for military radiocommunications technology when defining STANAGs.

AMBE is used for voice over data transmission under R&S®SECOM-V. It makes use of the R&S®SECOM-V 16000 bit/s channel with vocoder-specific FEC. This voice mode provides reliable good-quality and jam-proof communications. The data rate can be selected by HMI. The AMBE vocoder is ideal for the voice over data operating mode since it supports all R&S®SECOM-V data rates from 2400 bit/s to 16000 bit/s.

### R&S®SECOM-H (R&S®GS3001S)

- MELPe vocoder 600 bit/s
- MMBE vocoder 1200 bit/s
- AMBE vocoder 2400 bit/s

The 1200 bit/s vocoder was specially developed for the demanding task of setting up reliable links with good quality under the poor channel conditions usually found in the HF range. As an integral component of the R&S®SECOM-H HF waveform, it is optimized for use together with this frequency-hopping method. For interoperability with R&S®SECOM-V in rebroadcast applications, the 2400 bit/s vocoder can also be selected in the R&S®SECOM-H mode.

### R&S®SECOM-P (R&S®GS3030S)

- CVSD vocoder 16000 bit/s

### R&S®SECOS digital voice (R&S®GS3516S)

- CVSD vocoder 16000 bit/s
- AMBE vocoder 16000 bit/s

## Secure voice/data (R&S®GM4121S)

Secure voice/data (SVD) enables encrypted connections in FF channels. Just like for frequency-hopping R&S®SECOM waveforms, the R&S®RSCA crypto algorithm is used. SVD can be used standalone on FF channels or together with ALE 3G. MELPe vocoders are used to digitize the analog voice signals. In ALE 3G mode, SVD encryption can be applied to both voice and xDL data communications.

## Key features

- Fair to good speech quality
- Very robust realtime voice communications
- Automode capability
- Fast late entry capability

## Last ditch voice (R&S®GM4121S)

Poor quality HF channels are primarily a problem for tactical radio communications. In order to ensure reliable connections in such environments despite these disadvantages, the radio must employ extremely robust transmission methods: With LDV, the digitized voice message is first stored temporarily in the transmitting radio and then transmitted at data rates between about 30 bit/s and 300 bit/s using the LDL data protocol that is part of ALE 3G. This helps ensure that the recipient receives the voice messages under almost all circumstances, though not in realtime like a conventional voice call.

Messages up to 60 s are supported. Each station can store one LDV message. The user is informed about a new received LDV message at the HMI and via an audio indication. The user can also play back the received LDV message until a new LDV message is received.

## Voice over IP, SIP and phone patch

Voice over IP, especially with the SIP and RTP protocols, is standard today in many professional communications networks. The radios from the R&S®M3TR and R&S®M3SR Series4100 families have an IP interface as standard. Consequently, they can also be used to transmit digital voice to and from the radio. In addition to connecting radio networks via a local area network (LAN) or adding radio components to a LAN, the primary focus is on the following applications:

- Remote operation of tactical radios via standardized media, such as Ethernet, directional radio or satellite. One line or one channel suffices for voice traffic, data transmission and remote control
- Simple connection of the radios to telecommunications networks (phone patch) through the standardized IP interface

A phone patch is always of interest when a mobile device from a radio network is to be used to connect to a telephone network subscriber. This could be for public networks, but also for government or corporate networks. The phone patch is often part of a radio access point (RAP). The RAP acts as a gateway between radio networks and wireline networks. The R&S®M3TR and R&S®M3SR Series4100 radio families also offer state-of-the-art IP-based solutions for this application: Instead of analog telephone lines, LAN connections now establish

contact to the radio world. For transmission of the voice signals on the wireline side, the system supports standard protocols for IP telephony, such as SIP and RTP. A dedicated radio in the radio network serves as a gateway between the wireless and wireline networks. To do this, the radio connects to the receiving end via an SIP proxy router, which could, for instance, be an IP-enabled telephone. In this way, any subscribers in the radio network are able to reach the subscriber in the fixed network directly via the subscriber's network address. Telephone numbers can be stored conveniently in the radio; as a result, users can look up who they want to call in their radio's address book, just as they would on a mobile phone. The gateway radio also handles protocol conversion of the incoming RTP packets. In the radio network, work continues as usual with vo-coders that have been adapted to the radio channels.

In addition to the gateway between the wireless and wireline networks, it is also possible, of course, to link geographically separated radio networks via a LAN connection. This can be necessary when no direct radio contact is possible due to topographical conditions, or when LOS networks deployed at different locations are to be interconnected. Both the R&S®SECOM-H/R&S®SECOM-V waveforms and ALE 3G support this function.

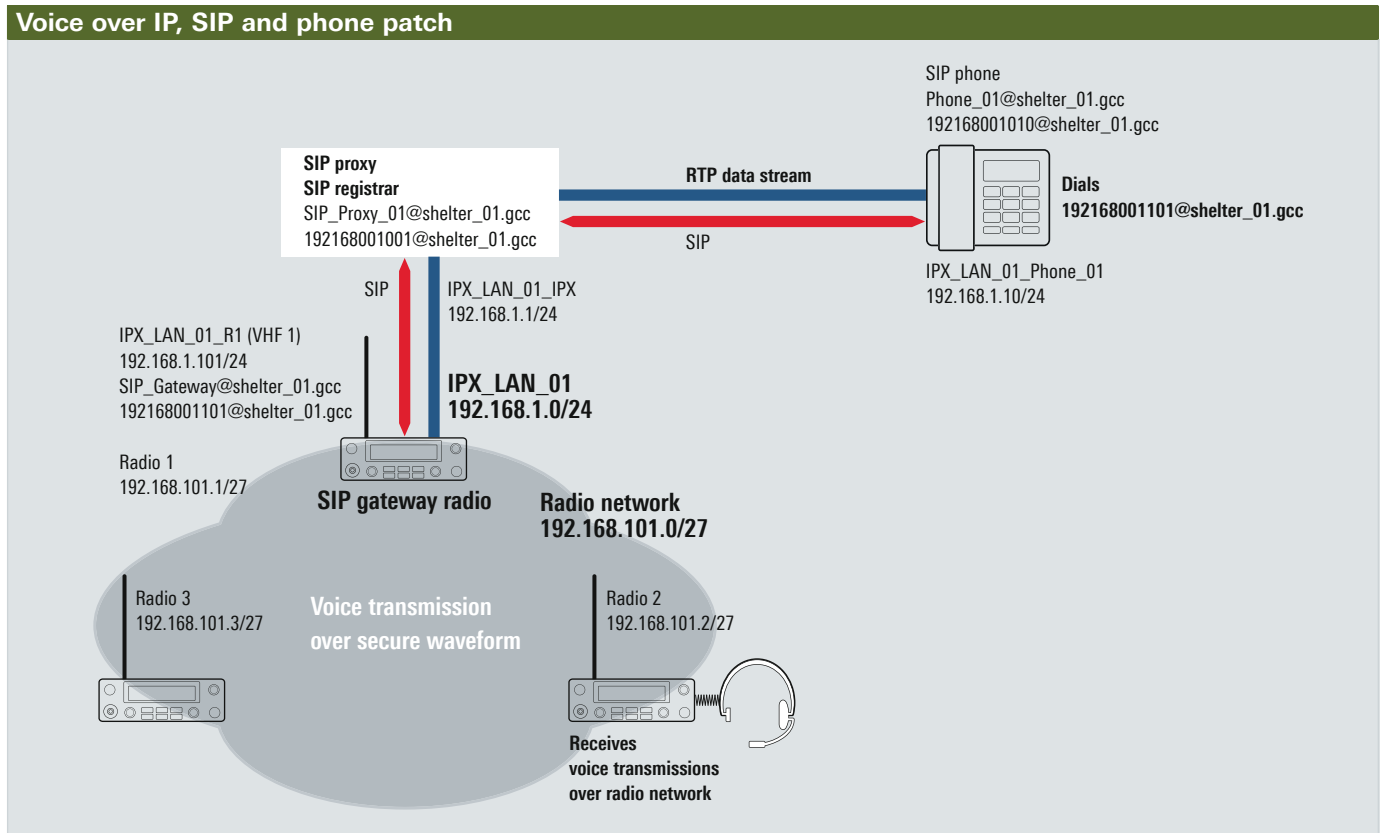

# R&S®MR300xH/ R&S®MR300xU supported services Data communications

## **Voice priority over data (VPoD)**

There is also a solution available for situations in which voice and data communications are simultaneously needed: Using VPoD, it is possible to interrupt an ongoing data link by simply pressing the push-to-talk key. Users can send emergency calls right from the ongoing data connection. After the emergency call is over, the radio returns to the original data transmission.

## **VPoD supported waveforms**

- ▮ R&S®SECOM-H
- ▮ R&S®SECOM-V
- ▮ ALE 3G (STANAG 4538) xDL

Note: To run HF waveforms on an R&S®MR300xU radio, the R&S®VK3150 power amplifier together with a docking station or the R&S®VK3150C compact amplifier and accessories such as an antenna coupler are required.

## **STANAG 4285 data mode (R&S®GM4120S)**

For backward interoperability, the non-self-identifying STANAG 4285 modem waveform is available. STANAG 4285 is a low and medium-rate maritime HF waveform from 75 bit/s to 3600 bit/s.

## **STANAG 4539 data mode (R&S®GM4120S)**

The STANAG 4539 HF modem enables self-identifying (auto-baud) data communications (up to 12 800 bit/s) in a 3 kHz channel in the HF frequency range.

STANAG 4539 is based on more than one standardized modem waveform:

- ▮ STANAG 4415 (very robust traffic waveform at 75 bit/s)
- ▮ MIL-STD-188-110B (low and medium-rate serial tone waveforms from 150 bit/s to 2400 bit/s)
- ▮ MIL-STD-188-110B App. C (high data rate waveforms from 3200 bit/s to 12 800 bit/s)

## **R&S®SECOM-H data mode (R&S®GS3001S)**

R&S®SECOM-H is designed to operate in environments where a certain percentage of hop set frequencies are blocked due to either intentional jamming or environmental interferences, e.g. atmospheric noise, thunderstorms or other electrical disturbances. For detailed information, see the related Technical Information (R&S®SECOM-H).

In R&S®SECOM-H, data rates from 75 bit/s to 2400 bit/s are possible. The data rates can be selected by HMI.

## **R&S®SECOS 5/16 TDMA (R&S®GS3516S)**

Data transmission with data rates of up to 16 000 bit/s is supported. Both TDMA and non-TDMA modes are implemented. For details on R&S®SECOS implementation in the R&S®M3TR, see the related Technical Information (R&S®SECOS).

### R&S®SECOM-V data mode (R&S®GS3030S)

In R&S®SECOM-V, data rates up to 16000 bit/s are possible. User data rates span from 600 bit/s to 9600 bit/s depending on FEC share and number of retransmissions. R&S®SECOM-V uses binary continuous phase FSK modulation with a shift of 6.25 kHz. For detailed information, see the related Technical Information (R&S®SECOM-V).

### 72 000 bit/s VHF/UHF modem (R&S®GS3030S)

For mobile radiocommunications, military users often employ terminal equipment with a narrow bandwidth and limited channel capacity. Such equipment has limited data transmission capability. The new software-based high-speed modem for the R&S®M3TR allows the transmission of radio data at high rates:

- Up to 72 000 bit/s
- Auto-baud capability

The modem can be operated either using the integrated IP over air protocol or transparently via the serial interface. It supports ten different waveforms with different data rates. All waveforms are operable in the VHF/UHF frequency range from 30 MHz to 512 MHz.

The VHF/UHF modem user data rate ranges from 16000 bit/s to 72000 bit/s, depending on the set bandwidth.

### R&S®IPoA – IP radio transmission

The R&S®IPoA embedded radio protocol provides transparent IP functionality over the air. It can be used to set up communications systems that require transparent connection of IP networks over radio links. IP-based applications – such as situational awareness or message handling systems – are enabled to exchange their data over such radio links.

An R&S®MR300xH/R&S®MR300xU radio equipped with R&S®IPoA includes static IP router functionality. The network structure can be configured very easily by entering IP subnets to be routed to different destinations over the air interface. This can be done very easily with the R&S®RNMS3000 network management system. In addition to the standard IP address of the physical Ethernet interface (which is used, for example, for remote control), a second IP address represents the radio's air interface. Using the configuration tool, the network can be configured to route e.g. wired IP subnets to different destinations over the air interface. The radio can be connected via an Ethernet connector (RJ-45) to 10BaseT and 100BaseT network equipment (such as hubs, switches and routers) provided by the R&S®KG3031/R&S®KG3032 docking station and the R&S®VT3050C compact power amplifier. If R&S®IPoA functionality is to be used with manpack radios, the R&S®MR300xH/R&S®MR300xU data connector on the front panel must be used. For this application, the Ethernet interface can be software-configured to this connector.

### R&S®IPoA – transparent IP data transfer over air

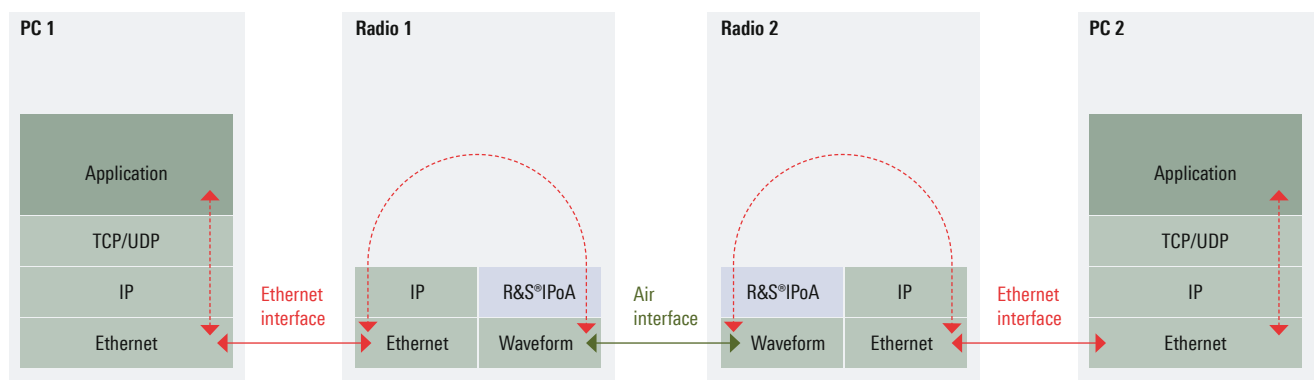

### R&S®IPoA protocol functionality

The embedded R&S®IPoA protocol currently supports Internet protocol version 4 (IPv4). An internal address mapping function ensures that data is delivered to the correct recipient. The IP packets are transmitted transparently over the radio channel. Data link performance depends on the current channel properties and propagation conditions of the radio link. An error detection mechanism prevents the protocol from delivering erroneous data to the connected network; further error correction techniques (e.g. ARQ secured data) are implemented.

### R&S®IPoA supported waveforms

- R&S®SECOM-H
- R&S®SECOM-V
- VHF/UHF modem
- ALE 3G (STANAG 4538) xDL

### R&S®IPoA message service

Messages and text information can be transmitted directly from the radio HMI as well as from external sources. Each R&S®IPoA-capable waveform supports the following applications:

#### Alarm messages

Alarm messages are messages that are preconfigured during mission planning. They can be selected on the HMI and then transmitted. Alarm messages place almost no load on the channel and are therefore always transmitted with the highest priority

#### Short data messages

Short data messages (SDM) can be entered directly on the HMI keyboard (similar to entering an SMS on a mobile phone). Addressing (PtP, PtM) is possible depending on the underlying waveform.

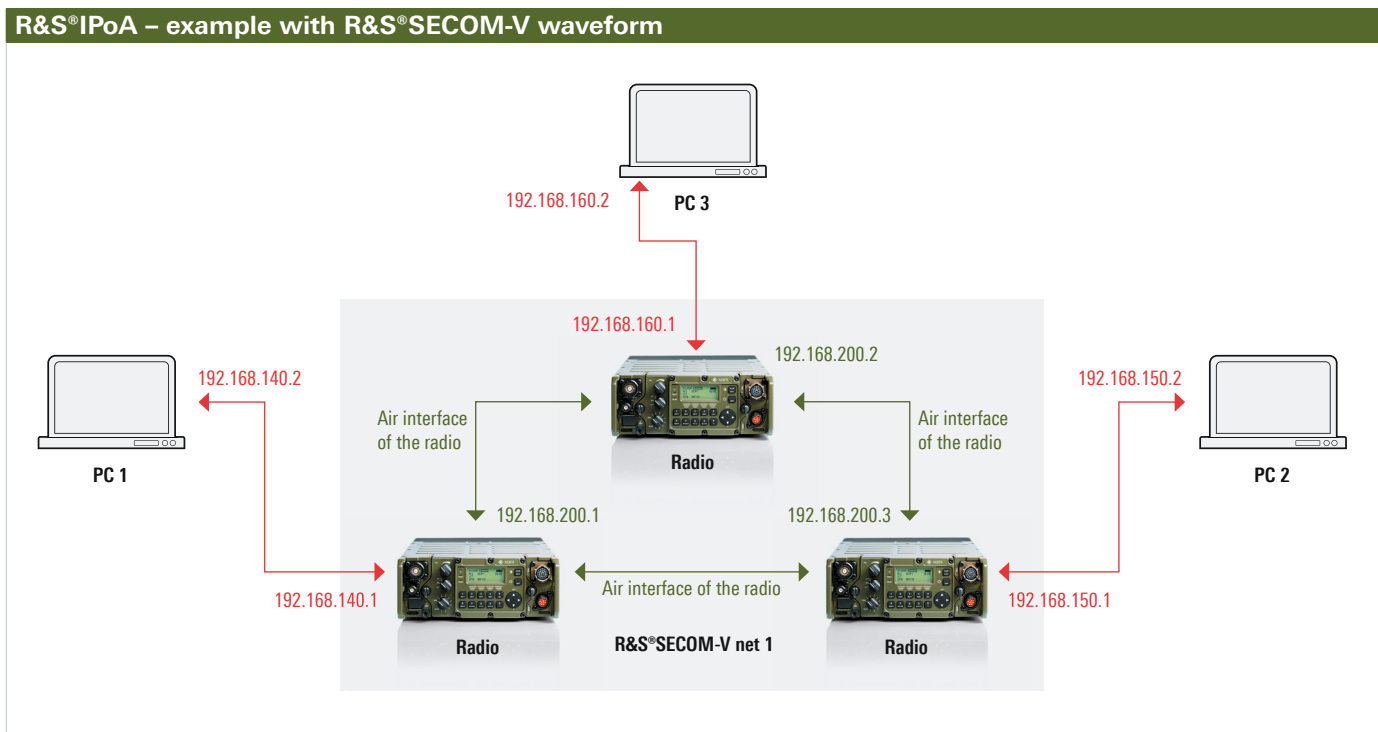



## R&S®IPoA – routing information

R&S®IPoA supports automatic routing of IP packets in networks with a fixed backbone (e.g. wired, SatCom or directional radio based) and a mobile, R&S®IPoA based structure. If a mobile radio operator (station Charlie in the figure below) changes from radio network A to the neighboring radio network B, all the operator needs to do is select the preset for the new R&S®IPoA network on the radio. As soon as the radio becomes active in the new network, the RIP gateway radio assigned to that network (station BRAVO in the figure below) automatically sends an RIP message to the RIP router in the fixed network. The radio has now been registered on the new network, and all IP packets addressed to Charlie will be routed to the new network.

An RIP router forwards incoming IP packets to the neighboring router that provides the shortest path to the destination (minimum number of hops; lowest metric). For stations that no longer generate IP traffic, the metric is increased at regular intervals until it reaches the maximum value preconfigured in R&S®RNMS, i.e. 16 (= unreachable = default value in R&S®RNMS). This ensures that when the radio has changed to a new network all messages transmitted reach their destination without the operator having to make any modifications to the network configuration.

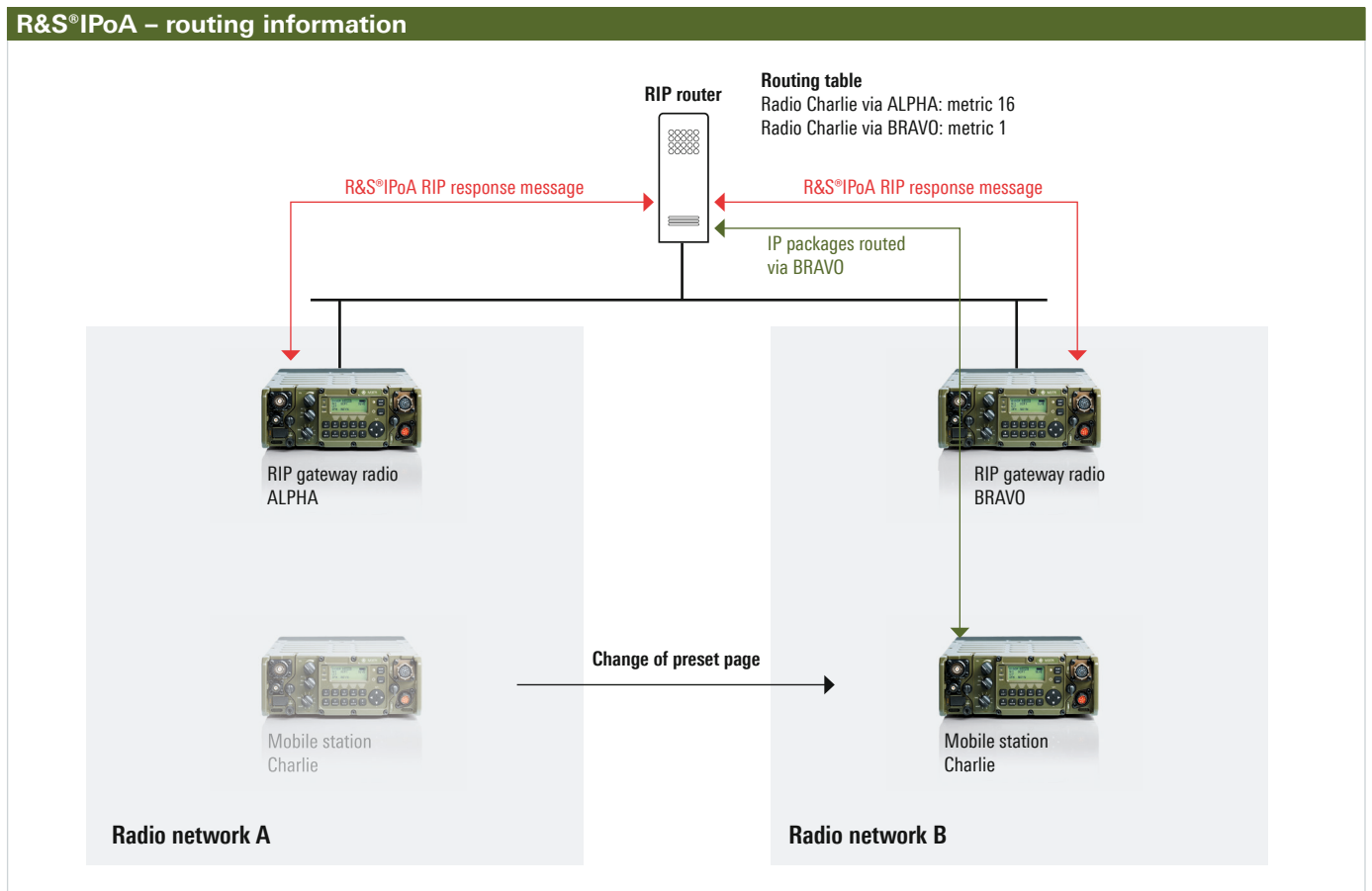

# R&S®M3TR

## supported services

### GPS services

#### GPS reporting

Operators can send their own position in a waveform-specific net. A dedicated radio (GPS controller) can poll the positions of all other net members. The GPS controller can be connected to an external application (i.e. command and control software system) to make GPS information available on a digital map, for example. The external application can poll the GPS controller to get the latest GPS information of all members of the network.

#### Transmission of GPS information

The polling of GPS information is initiated by the GPS controller. After initiation of transmission, all active GPS providers send their GPS information sequentially to the GPS controller. The transmission of GPS information can be switched on/off at the GPS controller. GPS reporting can be stopped in this way. Collisions between individual transmissions of GPS information are prevented.

#### GPS controller

The GPS controller is a manpack or vehicular radio (R&S®MR300xH/R&S®MR300xU). GPS controllers request the GPS information from the GPS providers either at a user's request or periodically.

#### GPS position information

The GPS controller stores the latest GPS information of each radio in an internal table. This table is updated each time GPS information is received by the GPS controller. The following GPS information is provided by each GPS provider radio:

- Position (WGS84, GEO, UTM, MGRS)
- Velocity
- UTC time
- Fix quality (number of satellites that are visible)

#### GPS reporting – supported waveforms

- R&S®SECOM-V
- R&S®SECOM-H
- R&S®SECOM-P
- VHF/UHF modem
- ALE 3G (STANAG 4538)

#### GPS receiver module on the R&S®MR300xH and R&S®MR300xU

The GPS receiver module is built into the manpack. The R&S®HV3003 GPS antenna or other embedded GPS antennas, e.g. R&S®HV3012, R&S®HV3013, R&S®HV3015, R&S®HV3019, are required to receive GPS signals.

#### GPS receiver module on the R&S®MR3000P (option)

A GPS receiver module is available for the R&S®MR3000P (handheld). It integrates both the GPS antenna and the receiver module and is connected to the audio connector of the handheld transceiver. External audio equipment can still be used with the GPS module installed.



R&S®HV3031 GPS receiver module for the R&S®MR3000P.

# R&S®M3TR

## supported services

### BIT

#### Built-in test system

All components of the R&S®M3TR radio system are equipped with a BIT system that provides three modes:

- Power-on BIT (PBIT)
- Initiated BIT (IBIT)
- Continuous BIT (CBIT)

The PBIT is always performed after powering on the unit.

The IBIT is executed when manually activated by the operator. The CBIT is continuously performed during operation.

The BIT enables fault location down to the module level of functional groups. Faults are stored in a fault journal for later evaluation.

#### Operating hours counter

- Display of operating time since last power-on operation
- Display of total operating time

#### PBIT

After power-on, the power-on built-in test (PBIT) starts automatically. The PBIT takes less than one second. It is a quick, reasonably in-depth test of the main functions such as the receive and transmit mode. The PBIT also detects installed modules and options and their versions.

#### IBIT

The initiated built-in test (IBIT) is the most in-depth of the built-in tests. It requires no additional equipment such as loop test cables, etc. The IBIT takes about five seconds.

#### CBIT

The continuous built-in test (CBIT) is the least in-depth of these tests. Unlike the PBIT and IBIT, it is a continuous test that runs in the background. The CBIT has no impact on radio operation or radio settings. The CBIT information is updated every second when the radio is switched on and in operating mode.

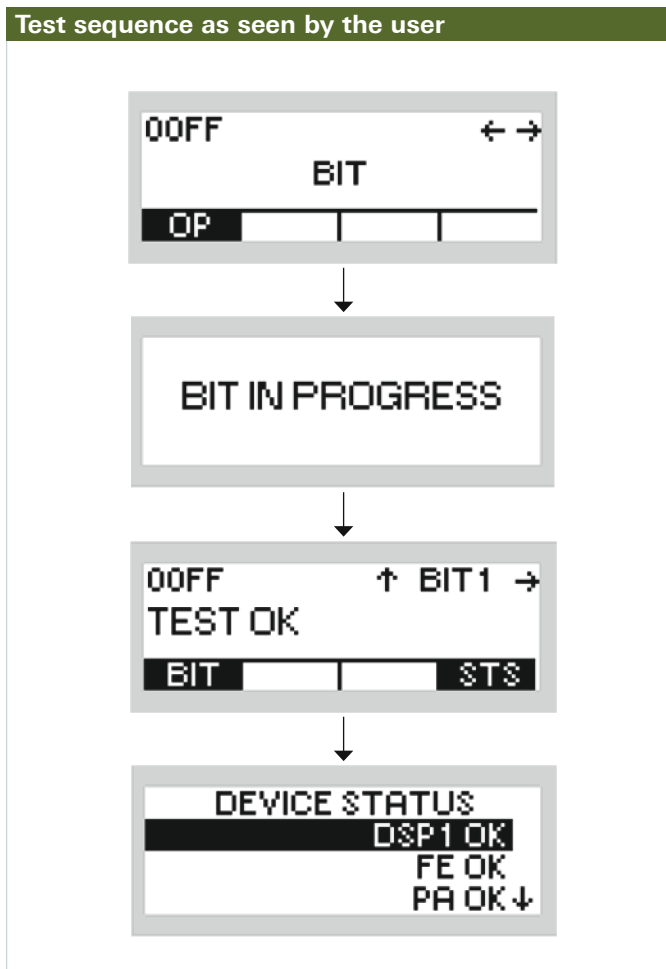

# R&S®M3TR

## supported services

### Channel/net

### memory

A radio can store different presets containing radio link data:

#### Nets

A net is a set of parameters specifying a configured FF or FH network containing all relevant data for link setup and traffic. Nets are stored in preset pages accessible by the rotary switch of the radio or by the keypad, respectively. Depending on the actual configuration, up to nine (R&S®MR3000P) or up to 99 (R&S®MR300xH/R&S®MR300xU) presets can be defined and stored in the radio.

#### Channels (R&S®MR300xH/R&S®MR300xU)

A channel is a set of parameters specifying an FF channel (TX and RX frequency, modulation, RF power, etc.). Channel data can be stored in both the manual preset or in

one of the remaining 99 presets. In total, 450 channels are available:

#### First 400 channels

- ▮ Can be generated during R&S®RNMS3000 configuration
- ▮ Can be entered directly at radio HMI
- ▮ Available on manual preset page (PP 0)

#### Locked channels

- ▮ If the above channels are locked during the R&S®RNMS generation process, they cannot be changed at the radio HMI

#### Remaining 50 channels

- ▮ To be generated during R&S®RNMS configuration only
- ▮ Will appear on their own preset page

#### Channel and band scanning

In the FF mode, it is possible to scan either the stored channels or a fixed frequency range. The user can define the dwell and hold time and the squelch type for the activity criterion. For band scanning, the user can set the start and stop frequency and the step width for the desired frequency range. If occupancy is detected, the scan can be stopped and the detected frequency stored in the channel memory. For channel scanning, the user can also define a priority channel.





### Mission planner – FF channel management

The screenshot shows the 'Mission Planner - RNMS3000 - Rohde & Schwarz' application. The left pane shows a tree view under 'Frequency Management' with sub-items: 'Barred Frequencies', 'Single Frequencies', and 'HF'. Under 'HF', there are 14 channels listed: ALECH1-11 (KHz) and HF01-14 (MHz). The main area shows 'RNMS3000 - Mission Planner'. A 'Fixed Frequency' dialog box is open, with the following fields: Name: channel 1, Description: VHF base 1, Imported from: (empty), Frequency: 35.025000 MHz, Channel Grid: 5 KHz. Buttons for 'Ok', 'Cancel', and 'Help' are at the bottom.

# Accessories for the R&S®MR300xH/ R&S®MR300xU Headset/handset/ loudspeaker

	Designation, description	Type
	<p><b>Handset with PTT, microphone and earpiece</b> The R&amp;S®GA3001 handset can be connected to the audio connector of the R&amp;S®MR300xH and R&amp;S®MR300xU radios, as well as to the remote control unit and other system components of the R&amp;S®M3TR radio family</p>	<p>R&amp;S®GA3001 Handset with PTT</p>
	<p><b>Headset with PTT, microphone and earpiece</b> The R&amp;S®GA3002 is a headset for single/double ear use and can be worn on both the right or left ear. A flexible cut-out polymer ear pad makes for user convenience without masking outside noise. The microphone is fitted to an adjustable flexible support</p>	<p>R&amp;S®GA3002 Headset with PTT</p>
	<p><b>Microphone/speaker</b> The R&amp;S®GA3003 consists of a loudspeaker box with built-in audio amplifier and microphone</p>	<p>R&amp;S®GA3003 Microphone/speaker</p>
	<p><b>Loudspeaker</b> For connection to the R&amp;S®M3TR audio socket with through-connection to R&amp;S®GA3001/R&amp;S®GA3002; 2 m, 5 m or 10 m cable</p>	<p>R&amp;S®GA3005 Loudspeaker</p>

# Batteries and battery chargers

	Designation, description	Type
	<p><b>Standard battery pack, Li-ion</b> rechargeable, 28.8 V/5.5 Ah</p> <p><b>Combat battery pack, Li-SO2</b> non-rechargeable, 28 V/7.5 Ah</p>	<p>R&amp;S®IB3001 Standard battery pack, Li-ion</p> <p>R&amp;S®IB3002 Combat battery pack, Li-SO2</p>
	<p><b>Battery charger, AC, stationary</b> Automatic charging of up to eight R&amp;S®IB3001 Li-ion batteries</p> <p>A power supply cable is supplied with each charger</p>	<p>R&amp;S®IC3000 Battery charger, AC, stationary</p>
	<p><b>Vehicle battery charger, DC, mobile</b> Automatic charging of one R&amp;S®IB3001 Li-ion battery</p> <p>Power supply cable for R&amp;S®IC3001 vehicle battery charger, delivery without battery pack</p>	<p>R&amp;S®IC3001 Vehicle battery charger, DC, mobile</p> <p>R&amp;S®GK3020 Power supply cable</p>
	<p><b>Battery charger set</b> for connection to R&amp;S®IC3001 or R&amp;S®IV3001</p>	<p>R&amp;S®ZR3001 Battery charger set</p>

# Antenna tuning unit and auxiliary equipment

	Designation, description	Type
	<p><b>Antenna tuning unit</b></p> <p>Shown with recommended extra: mounting frame</p>	<p>R&amp;S®FK3150 Antenna tuning unit, 150 W</p> <p>Recommended extra: R&amp;S®KS3150F mounting frame</p>
	<p><b>Single remote control unit</b> with 3.5 m, 8 m or 12 m connecting cable</p>	<p>R&amp;S®GB3031R Single remote control unit</p>
	<p><b>Connecting cable for detachable front panel</b> max. 1.5 m length</p>	<p>R&amp;S®GK3005 Connecting cable</p>
	<p><b>Fillgun</b> for R&amp;S®M3TR and R&amp;S®M3SR Series4100; for transmitting all relevant preset information as well as COMSEC/TRANSEC keys</p>	<p>R&amp;S®GP3000 fillgun R&amp;S®GP3100 fillgun (HAVE QUICK I/II mode)</p> <p>R&amp;S®GK3021 USB cable, fillgun to PC</p>

# Docking stations

	Designation, description	Type
	<p><b>Single docking station with blower</b> For installation of one R&amp;S®MR300xH or R&amp;S®MR300xU manpack radio</p>	<p>R&amp;S®KG3031 Single docking station</p>
	<p><b>Dual docking station</b> For applications requiring the simultaneous operation of two radio stations</p>	<p>R&amp;S®KG3032 Dual docking station</p>
	<p><b>Universal RCB converter</b> The R&amp;S®GH3041 provides conversion functionalities between coaxial RCB interfaces (as used in R&amp;S®M3TR applications) and optical RCB interfaces (as used in R&amp;S®M3SR Series4100 applications) and vice versa, i.e. to be used in connection with the R&amp;S®FK4115M antenna tuning unit</p>	<p>R&amp;S®GH3041 Universal RCB converter</p>
<p><b>Various mounting frames for wheeled and tracked vehicles are available</b></p>		





# Antenna selection chart – HF band

Model	Frequency range	Power	Mast	Application	Type
<b>R&amp;S®HV3007</b> 	1.5 MHz to 30 MHz	25 W	n.a.	For manpack applications	R&S®HV3007 Whip antenna
<b>R&amp;S®AK3001</b> 	1.5 MHz to 30 MHz	150 W	n.a.	For manpack applications, long wire adapter, R&S®GK3019 model .04 required	R&S®AK3001 Wire antenna
<b>R&amp;S®AK3031</b> 	2 MHz to 90 MHz	25 W	R&S®KM3032	For manpack applications, BNC adapter, R&S®GK3019 model .02 required	R&S®AK3031 Wire dipole antenna
<b>R&amp;S®HA104</b> 	1.5 MHz to 30 MHz	150 W	n.a.	For vehicle applications, suitable for ground waves and vertically polarized low-angle sky waves, R&S®FK3150 antenna tuning unit required	R&S®HA104 Whip antenna
<b>R&amp;S®AK503</b> 	1.5 MHz to 30 MHz	150 W	R&S®KM011	For vehicle applications, R&S®FK3150 antenna tuning unit required	R&S®AK503 HF antenna system for mobile use

# Antenna selection chart – VHF band

Model	Frequency range	Power	Mast	Application	Type
R&S®HV3004 	25 MHz to 108 MHz	25 W	n.a.	For manpack applications	R&S®HV3004 Whip antenna
R&S®HV3020 	25 MHz to 108 MHz	25 W	n.a.	For manpack applications, long radiator	R&S®HV3020 Whip antenna
R&S®HD3088 	30 MHz to 88 MHz	12.6 W	n.a.	For manpack applications BNC adapter, R&S®GK3019 model .02 required	R&S®HD3088 Hang-up antenna
R&S®HD3001 	30 MHz to 88 MHz	25 W	n.a.	For manpack applications, high-gain directional antenna	R&S®HD3001 Long wire antenna
R&S®HV3021 	25 MHz to 146 MHz	5 W	n.a.	For handheld applications, long radiator	R&S®HV3021 Long tape antenna
R&S®HV3022 	25 MHz to 146 MHz	5 W	n.a.	For handheld applications	R&S®HV3022 Short tape antenna
R&S®HV3012 	30 MHz to 108 MHz	50 W	n.a.	For vehicle applications, low-profile antenna	R&S®HV3012 Whip antenna
R&S®HV3015 	30 MHz to 108 MHz	50 W	R&S®KM3031	For vehicle and stationary applications	R&S®HV3015 Whip antenna
R&S®HV3088L 	30 MHz to 88 MHz	5 W	n.a.	For handheld transceivers	R&S®HV3088L Long tape antenna, foldable

# Antenna selection chart – VHF/UHF band

Model	Frequency range	Power	Mast	Application	Type
<b>R&amp;S®HV3009</b> 	118 MHz to 400 MHz	15 W	n.a.	For manpack applications	R&S®HV3009 Whip antenna
<b>R&amp;S®HV3013</b> 	225 MHz to 450 MHz	50 W	R&S®KM3031	For vehicle and stationary applications	R&S®HV3013 Whip antenna
<b>R&amp;S®HV3019</b> 	100 MHz to 512 MHz	50 W	R&S®KM3031	For vehicle and stationary applications	R&S®HV3019 Whip antenna
<b>R&amp;S®HK055L1</b> 	27.5 MHz to 600 MHz	50 W < 30 MHz, 100 W > 30 MHz	R&S®KM055	For vehicle applications	R&S®HK055L1 Broadband mobile antenna
<b>R&amp;S®HK061</b> 	30 MHz to 600 MHz	100 W	n.a.	For vehicle and stationary applications	R&S®HK061 Broadband vehicle communications antenna

# Accessories for the R&S®MR3000P tactical handheld transceiver

	Designation, description	Type
	<b>Handheld microphone/speaker</b>	R&S®GA3023 Handheld microphone/speaker
	<b>Headset with PTT or VOX</b>	R&S®GA3022 Headset
	<b>Battery pack, Li-ion</b> For handheld transceiver	R&S®IB3022 Battery pack, Li-ion
	<b>Universal battery charger, AC, stationary</b> For handheld transceiver; automatic charging of up to eight R&S®IB3022 Li-ion batteries	R&S®IC3022 Universal battery charger, AC, stationary
	<b>Vehicle support</b> Vehicle mount with charger	R&S®IV3021 Vehicle support
	<b>Fillgun</b> For transmitting all relevant preset information as well as COMSEC/TRANSEC keys	R&S®GP3021 Fillgun
	<b>Vehicle battery charger, DC</b> Automatic charging of two R&S®IB3022 Li-ion batteries	R&S®IC3023 Vehicle battery charger, DC
	<b>Battery charger, AC, mobile</b> Charger, AC, mobile for handheld transceiver; automatic charging of one R&S®IB3022 Li-ion battery	R&S®IC3024 Charger, AC
	<b>GPS receiver</b> TAIP interface	R&S®HV3031 GPS receiver

# External amplifiers Configuration overview with docking station and power amplifiers

## External amplifiers – overview

- ▮ 50 W VHF/UHF power amplifier, standalone unit
- ▮ 50 W VHF/UHF power amplifier, compact version
- ▮ 150 W HF power amplifier, standalone unit
- ▮ 150 W HF power amplifier, compact version
- ▮ 500 W HF power amplifier

### VHF/UHF antennas

- ▮ VHF
- ▮ UHF
- ▮ Multiband



### HF antennas

- ▮ Whip
- ▮ Wire
- ▮ NVIS



R&S®KG3031A <sup>1) 2)</sup>  
single docking station



R&S®VT3050 50 W <sup>1)</sup>  
VHF/UHF power amplifier



R&S®VK3150 <sup>2)</sup>  
150 W HF amplifier



R&S®FK3150 <sup>3)</sup>  
antenna tuning unit



Power supply

<sup>1)</sup> The R&S®KG3031A and the R&S®VT3050 can be replaced with the R&S®VT3050C.

<sup>2)</sup> The R&S®KG3031A and the R&S®VK3150 can be replaced with the R&S®VK3150C.

<sup>3)</sup> The R&S®FK3150 can be replaced with the R&S®FK4115M and the R&S®GH3041.

# R&S®VT3050 50 W VHF/UHF power amplifier

## Brief description

**The R&S®VT3050 50 W VHF power amplifier supports continuous operation across the 30 MHz to 512 MHz band with 50 W transmit power.**

The R&S®VT3050 is a member of the R&S®M3TR family of multiband tactical radio systems. This power amplifier meets the need for military voice and data communications in all analog and digital fixed-frequency and frequency-hopping modes supported by the R&S®MR300xH/R&S®MR300xU tactical radio. The amplifier is especially designed for high linearity to satisfy the requirements of the R&S®M3TR's high-speed radio modem for 72 000 bit/s. Furthermore, it supports medium to fast frequency hopping.

A collocation option is available for the VHF low band (30 MHz to 88 MHz). The co-site filter is factory-installed. Fully automatic operation (controlled from the transceiver) and rapid tuning capability are provided.

Operational configuration and BITE/fault status reporting are performed via the radios. The R&S®VT3050 uses rugged tactical packaging and meets the same environmental specifications for temperature, shock, vibration and submersibility as the rest of the R&S®M3TR family. Operation is fully automatic. Built-in test equipment (BITE) and diagnostic testing are fully integrated into the radio system. The VHF/UHF amplifier is mounted separately with an independent shockmount. This provides additional flexibility when installing tactical radio systems into vehicles.

An R&S®M3TR VHF/UHF system can be easily upgraded to multiband operation. The serial control bus of the R&S®M3TR allows combinations of radios with up to two external amplifiers. By adding an R&S®VK3150 HF amplifier and an R&S®FK3150 antenna tuning unit, the system can be expanded to a frequency range of 1.5 MHz to 512 MHz.

For use with standard VHF and UHF antennas, the amplifier features two configurable RF outputs. The frequency that splits the available frequency range of 30 MHz to 512 MHz is user-selectable. Possible settings could be, for instance, 30 MHz to 108 MHz for the RF<sub>Low</sub> output leaving 108 MHz to 512 MHz for the RF<sub>High</sub> output. If a multiband antenna such as the R&S®HK055L1/R&S®HK061 is used, the entire range of 30 MHz to 512 MHz can be routed to one of the outputs.



R&S®VT3050 50 W VHF/UHF power amplifier.

# R&S®VT3050C 50 W VHF/UHF compact power amplifier

## Brief description

The R&S®VT3050C 50 W VHF/UHF compact power amplifier accommodates an R&S®MR300xU or R&S®MR300xH manpack radio.

The R&S®VT3050C supports continuous operation across the 30 MHz to 512 MHz band with 50 W transmit power. The R&S®VT3050C accepts an R&S®MR300xU or R&S®MR300xH manpack radio (not included in the equipment supplied) as a plug-in exciter. Because each R&S®MR300xH/R&S®MR300xU manpack radio features a rear system connector, the radio can be mounted and dismounted quickly. Connectors on the front panel provide the most important interfaces such as RF, audio, power supply lines and a digital bus to control external equipment. For standard applications, it is not necessary to plug cables to the radio's front panel. This provides "jerk and run" capability in an emergency, or convenient handling if the radio is temporarily used as a manpack. The R&S®VT3050C operates on 24 V or 12 V (with reduced output power) vehicle power supply.

## Key features

- ▮ Frequency range from 30 MHz to 512 MHz
- ▮ Very compact, easy to install
- ▮ Output power of 50 W CW and PEP
- ▮ Frequency-hopping capability (HAVE QUICK I/II, R&S®SECOM-V, R&S®SECOM-P, R&S®SECOS)

- ▮ Protected against antenna mismatch, overload, overvoltage
- ▮ High MTBF
- ▮ Upgradeable to multiband operation (interface for R&S®VK3150 HF power amplifier, 1.5 MHz to 512 MHz)

## Options

### Co-site filter

A collocation option is available for the VHF low band (30 MHz to 88 MHz). The co-site filter is factory-installed. Fully automatic operation (controlled from the host radio) and rapid tuning capability are provided.

### Field telephone interface

This option provides a two-wire interface to connect the amplifier to a field telephone. The operator can select four modes for routing telephone calls from and to the radio:

- ▮ Audio-Radio: audio interface connected to radio
- ▮ Radio-Phone: field telephone connected to radio
- ▮ Audio-Phone: field telephone connected to audio interface
- ▮ Audio-Radio-Phone: field telephone connected to radio and audio interface

### Audio/data interface

This option provides a versatile audio/data interface including power lines, audio, data and control signals. It is used to connect external devices such as an ELCRODAT 4-2, R&S®MMC3000 or KY57 cipher unit.

### MIL-STD-188-220B modem interface

This option makes it possible to set up radio data networks in line with the MIL-STD-188-220B standard (interoperability standard for digital message transfer device subsystems). The IP-based protocol supports up to 32 network nodes in fixed-channel operation.



The R&S®VT3050C with options. (The radio is not part of the equipment supplied.)

# R&S®VK3150 150 W HF power amplifier

## Brief description

The R&S®VK3150 150 W HF power amplifier increases the HF output power of the R&S®MR300xH/R&S®MR300xU manpack radios to 150 W PEP or 100 W average.

The R&S®VK3150 provides medium-power/medium-range communications links. Typical applications include mobile or base station installations for general-purpose HF SSB voice and data communications.

Continuous coverage is provided over the 1.5 MHz to 30 MHz frequency range. The power amplifier section has a broadband design and fully supports frequency-agile operating modes (automatic link establishment, slow frequency hopping). When used with the automatic R&S®FK3150 HF antenna tuning unit, the output of the R&S®VK3150 is automatically matched to most rod and whip antennas.

Built-in self-test features permit operators or maintenance personnel to fully check the radio and the power amplifier down to module level. Fault conditions are displayed on the radio's front-panel display.

The R&S®MR300xH/R&S®MR300xU manpack acts as an exciter for the power amplifier, avoiding the disadvantages of radio/booster solutions with respect to unwanted emissions. The HF power amplifier is mounted separately on an independent shockmount with room for proper air flow. This provides additional flexibility when installing tactical radio systems into vehicles.

The R&S®VK3150 uses rugged tactical packaging and meets the same environmental specifications for temperature, shock, vibration and submersibility as the rest of the R&S®M3TR family.



R&S®VK3150 150 W HF power amplifier.



# R&S®VK3150C

## 150 W HF compact power amplifier

### Brief description

The R&S®VK3150C is an HF power amplifier for the R&S®MR300xU and R&S®MR300xH manpack radios. The R&S®VK3150C makes it possible to configure very compact HF stations with a maximum output power of 150 W. The power amplifier is therefore ideal for mobile deployment scenarios in tactical radio applications. Like the R&S®VT3050C, its VHF/UHF counterpart, all R&S®MR300x manpacks can be operated as exciters by simply plugging them into the amplifier. If the need arises for a portable radio during the mission, the manpack can be easily removed from the power amplifier, without having to disconnect cables or use tools. The R&S®VK3150C seamlessly and fully supports all Rohde&Schwarz HF waveforms, including frequency hopping and ALE processes.

The power amplifier comes with a wide range of standard interfaces, such as audio and Ethernet, as well as interfaces to a VHF/UHF power amplifier and antenna couplers for smooth system integration. The R&S®VK3150C also offers options that allow, for example, external cryptographic devices to be used.

### Key features

- ▮ Frequency range from 1.5 MHz to 30 MHz
- ▮ Output power of 150 W PEP
- ▮ Extremely compact, easy to install on all mobile platforms
- ▮ Wide input voltage range
- ▮ Full support of frequency-agile HF waveforms (EPM, ALE)
- ▮ Optical and coaxial ATU interface
- ▮ Upgradeable to multiband operation (interface for R&S®VT3050 VHF/UHF power amplifier, 1.5 MHz to 512 MHz)

### Options

#### Field telephone interface

This option provides a two-wire interface to connect the amplifier to a field telephone. The operator can select four modes for routing telephone calls from and to the radio:

- ▮ Audio-Radio: audio interface connected to radio
- ▮ Radio-Phone: field telephone connected to radio
- ▮ Audio-Phone: field telephone connected to audio interface
- ▮ Audio-Radio-Phone: field telephone connected to radio and audio interface

#### Audio/data interface

This option provides a versatile audio/data interface including power lines, audio, data and control signals. It is used to connect external devices such as an ELCRODAT 4-2, R&S®MMC3000 or KY57 cipher unit.



The R&S®VK3150C with options. (The radio is not part of the equipment supplied.)

# R&S®MG3500

## 500 W HF power amplifier

### Brief description

The R&S®MG3500 power amplifier increases the HF output power of an R&S®MR300xH/R&S®MR300xU radio in the HF range up to max. 500 W.

This makes reliable medium- and long-range connections via ground wave and sky wave possible. Typical applications include stationary and semi-mobile installations for tactical radio networks.

### Key features

- ▮ Frequency range from 1.5 MHz to 30 MHz
- ▮ Output power of 500 W CW and PEP
- ▮ Frequency-hopping capability (R&S®SECOM-H)
- ▮ Protected against mismatch and short-circuit
- ▮ High MTBF



The R&S®MG3500 500 W power amplifier with the radio in shockmounted frame (option). (The radio is not part of the equipment supplied.)

## Operating modes

The amplifier operates in the entire HF range from 1.5 MHz to 30 MHz. In addition to the analog modes (AM, FM, SSB), frequency-agile radio techniques such as ALE and R&S®SECOM-H offered in the R&S®M3TR are also supported.

Broadband antennas (VSWR < 2) can be directly connected to the amplifier. If the R&S®FK4190M antenna tuning unit is added, standard rod, whip or wire antennas can also be operated. In this case, the R&S®FK4190M is automatically controlled and tuned by the receiver. Furthermore, hop sets and scan groups for the frequency-agile modes are learned for the connected antenna, and the associated data records are stored in the tuning unit. The tuning processes are largely performed automatically and do not require the operator to take any special steps.

## Reliability

The R&S®MG3500 is fully integrated into the built-in test (power-on test and continuous test) of the radio. Error messages from the amplifier are output on the radio HMI for the operator. To make service easier, error messages down to the module level can be called up.

## Power supply

The R&S®MG3500 can operate in either single-phase or three-phase mode. In addition, emergency operation from a 24 V DC power supply is possible (max. HF output power is then 100 W).

## Environmental and EMC properties

Like all system components of the R&S®M3TR family, the R&S®MG3500 has also been subjected to rigorous quality testing. It meets the requirements of the MIL-STD-810F and MIL-STD-461E standards.

## Multiband extension

All R&S®MR300xH/R&S®MR300xU radios support multi-band operation. The frequency range of an R&S®M3TR HF system equipped with the R&S®MG3500 can also be extended to cover the VHF/UHF range. This is done by connecting the R&S®MG3500 to the extension port of an R&S®VT3050C amplifier. This combination then permits continuous operation at all frequencies between 1.5 MHz and 512 MHz. Moreover, this configuration supports all R&S®M3TR EPM (ECCM) and modem options in the VHF and UHF range.

## Design

The R&S®MG3500 HF power amplifier is modular with 19" rackmount design. Any R&S®MR300xH/R&S®MR300xU radio can be operated as an exciter for controlling the R&S®MG3500 power amplifier. It can be replaced without requiring tools, or it may be used temporarily as a manpack radio. The interfaces on the manpack radio (audio, serial data/control, GPS antenna connector, etc.) of course remain accessible even after the radio has been installed in the R&S®MG3500.

# R&S®IV3001 power supply unit

## Brief description

The R&S®IV3001 power supply unit is a DC-powered vehicle mounting frame for R&S®MR300xU and R&S®MR300xH manpack radios. The R&S®IV3001 is ideal for platforms that are limited in terms of vehicle load capacity, space and power. The internal manpack power amplifier of an R&S®MR300xU or R&S®MR300xH eliminates the need for expensive, external amplifiers that heavily load the onboard power supply.

This configuration still provides output power up to 10 W in the VHF band (plus up to 10 W in the UHF band and 20 W in the HF band, dependent on the manpack version). Therefore, when used with powerful antennas, these systems provide sufficient radio coverage for vehicles that are not suitable for conventional radio equipment, i.e. small jeeps, quads, inflatable dinghies, etc. If more output power is needed, the R&S®IV3001 can be connected to external power amplifiers (R&S®VK3150 or R&S®VT3050). All R&S®IV3001 models can be ordered with or without an integrated charger.

All R&S®IV3001 models come with an Ethernet interface for remote control and data transfer.

## Key features

- ▀ Operation with internal manpack power amplifier or connection to external amplifier
- ▀ Installation without additional shockmounting for wheeled and tracked vehicles
- ▀ Extremely compact, easy to install on all mobile platforms
- ▀ 12 V or 24 V operation, low power consumption
- ▀ UPS functionality, automatic switchover to a connected R&S®IB3001 battery when the vehicle power supply fails
- ▀ Wide range of interfaces
- ▀ Optional charger, functionality for loading connected R&S®IB3001 batteries
- ▀ Upgradeable to multiband operation (interface for R&S®VT3050 VHF/UHF power amplifier or R&S®VK3150 HF power amplifier)



R&S®IV3001 power supply unit. (The radio is not part of the equipment supplied.)

# R&S®RNMS3000 radio network management system

## Utilization planning, radio network configuration and data distribution

### Increased significance for a radio network management system

In today's world, information exchange via voice and data is indispensable for military forces to fulfill their increasing mission requirements. Handling all these communications demands with their complex waveforms requires an extended network management system. By offering R&S®RNMS3000, Rohde&Schwarz provides such a radio network management system. It enables military leaders to turn their Rohde&Schwarz combat radio equipment into a robustly networked communications system based on mission demand and on complex hierarchical structures, especially in joint or combined missions. In the past, many parameters had to be adjusted on the radios, which required highly skilled users. In future, the configuration complexity will be done during the preparative configuration of a management system.

### R&S®RNMS3000 – the convenient way to empower the capabilities of Rohde & Schwarz radios in networks

The R&S®RNMS3000 software supports the centralized network management, where one central organizational unit performs the complete mission planning, as well as the decentralized management, where the various configuration steps are accomplished on different military hierarchical levels. The R&S®RNMS3000 software suite, consisting of the mission planner, the remote device loader and the remote distributor, offers the following functions:

- Management of security keys
- Frequency assignments
- Establishment of logical nets
- Distribution of mission files

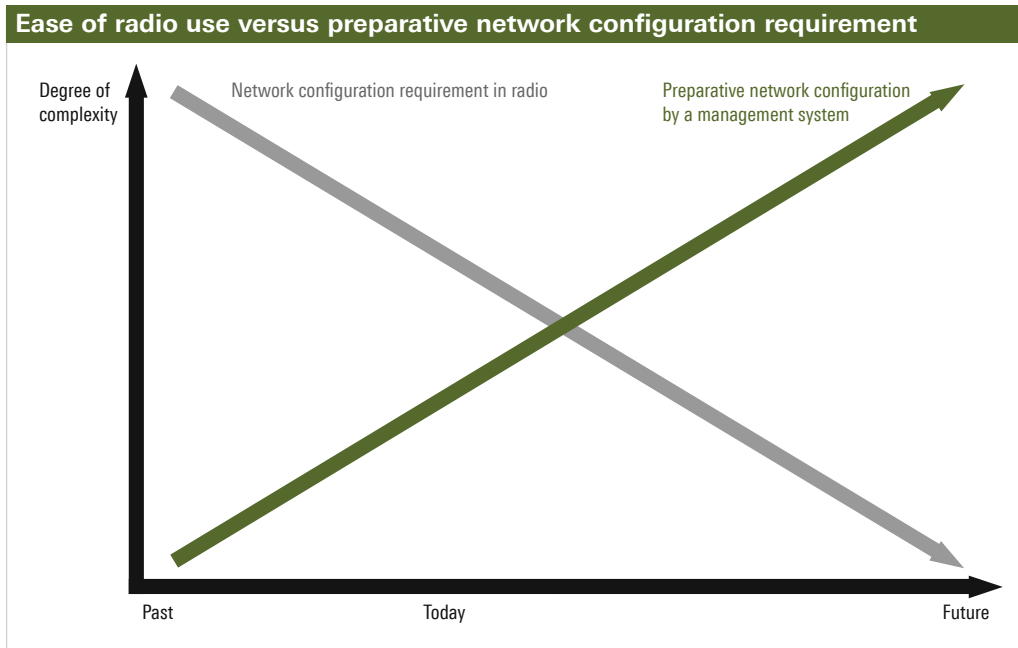

The objective is to provide mission-tailored and secured radiocommunications networks. Especially the R&S®RNMS3000 capability to manage NATO-specific waveforms, as well as general HF House waveforms and Rohde&Schwarz proprietary waveforms, underlines its broad range of applications.

### Comprehensive waveform support

- ▮ NATO waveforms
- ▮ HF House waveforms
- ▮ R&S®SECOM waveforms
- ▮ R&S®SECOS waveform

### Highlights

- ▮ Support of all Rohde&Schwarz radios and all frequencies
- ▮ Support of voice and data services
- ▮ Network planning, mission file generation and distribution with one software suite
- ▮ Target-oriented software guidance with wizards

### Key features

#### Mission planner – mission-tailored network planning

- ▮ Frequency assignment
- ▮ Hop set generation and management
- ▮ Security key management
- ▮ Efficient mission planning

#### Remote device loader – mission-optimized radiocommunications plan transfer

- ▮ Secure file transfer
- ▮ Effective hardware programming

#### Remote distributor – extended mission data distribution

- ▮ File distribution over existing IP networks
- ▮ Event log and status control

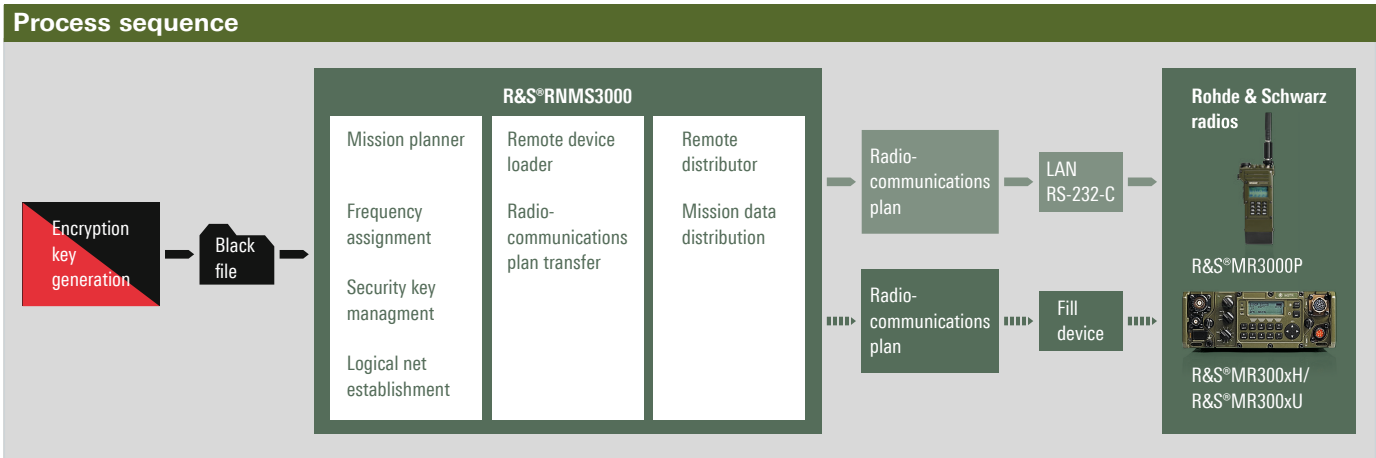

## Effective mission planning

The mission planner software allows mission-optimized and time-critical software use. The program provides target-oriented software navigation via wizards to allow the operator mission planning with a focus on the essential parameters. In case of a configuration error, R&S®RNMS3000 displays a fault message including advice to support the error search process. The created mission file and configuration progress are saved automatically in a database to avoid losing critical mission data due to a hardware failure.

Geographical display of a mission area.

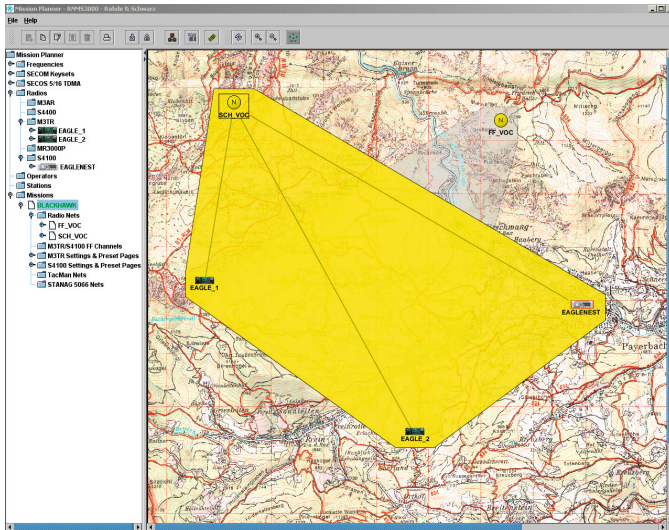

## Geographical dispersed radio network planning

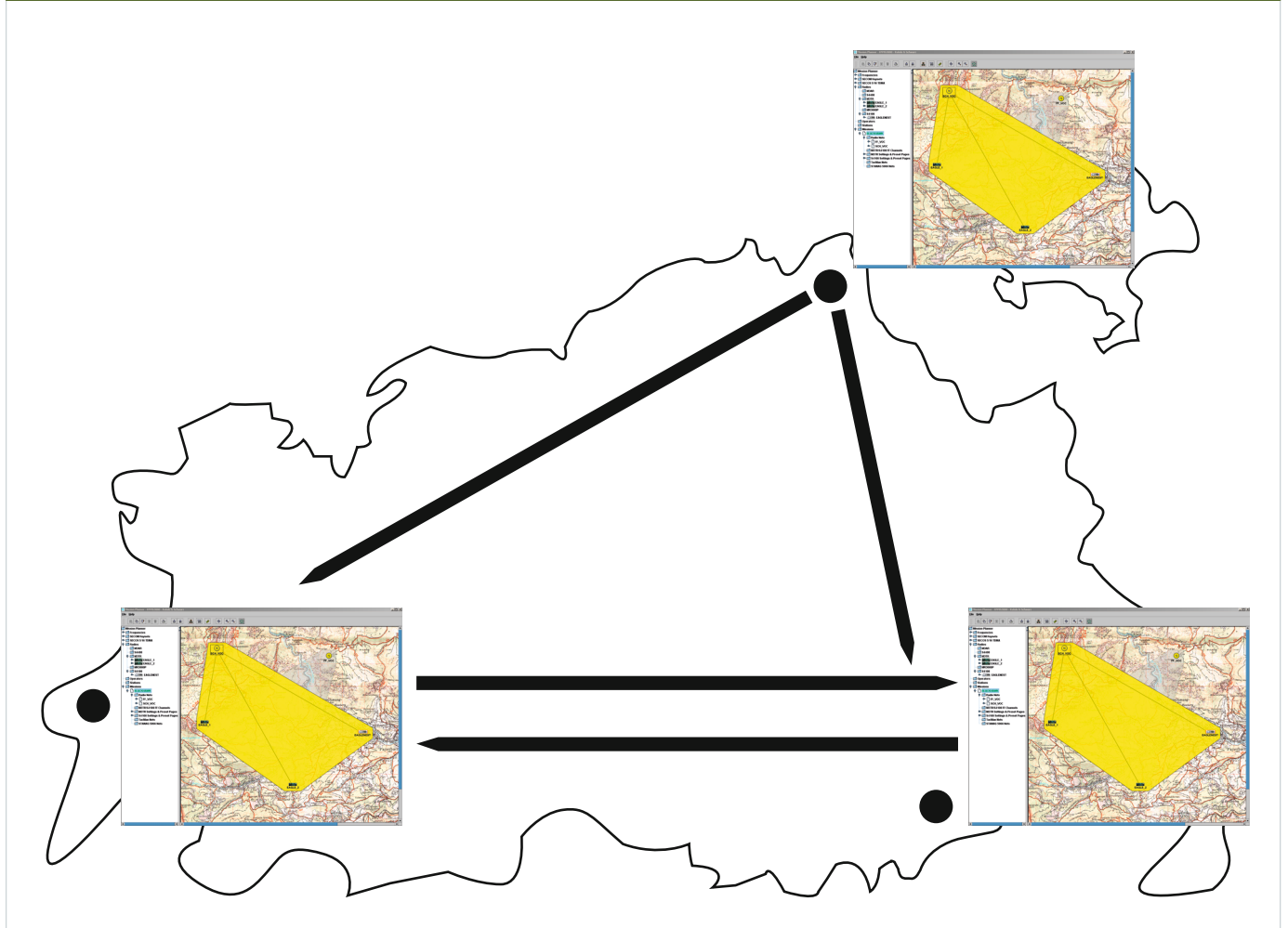

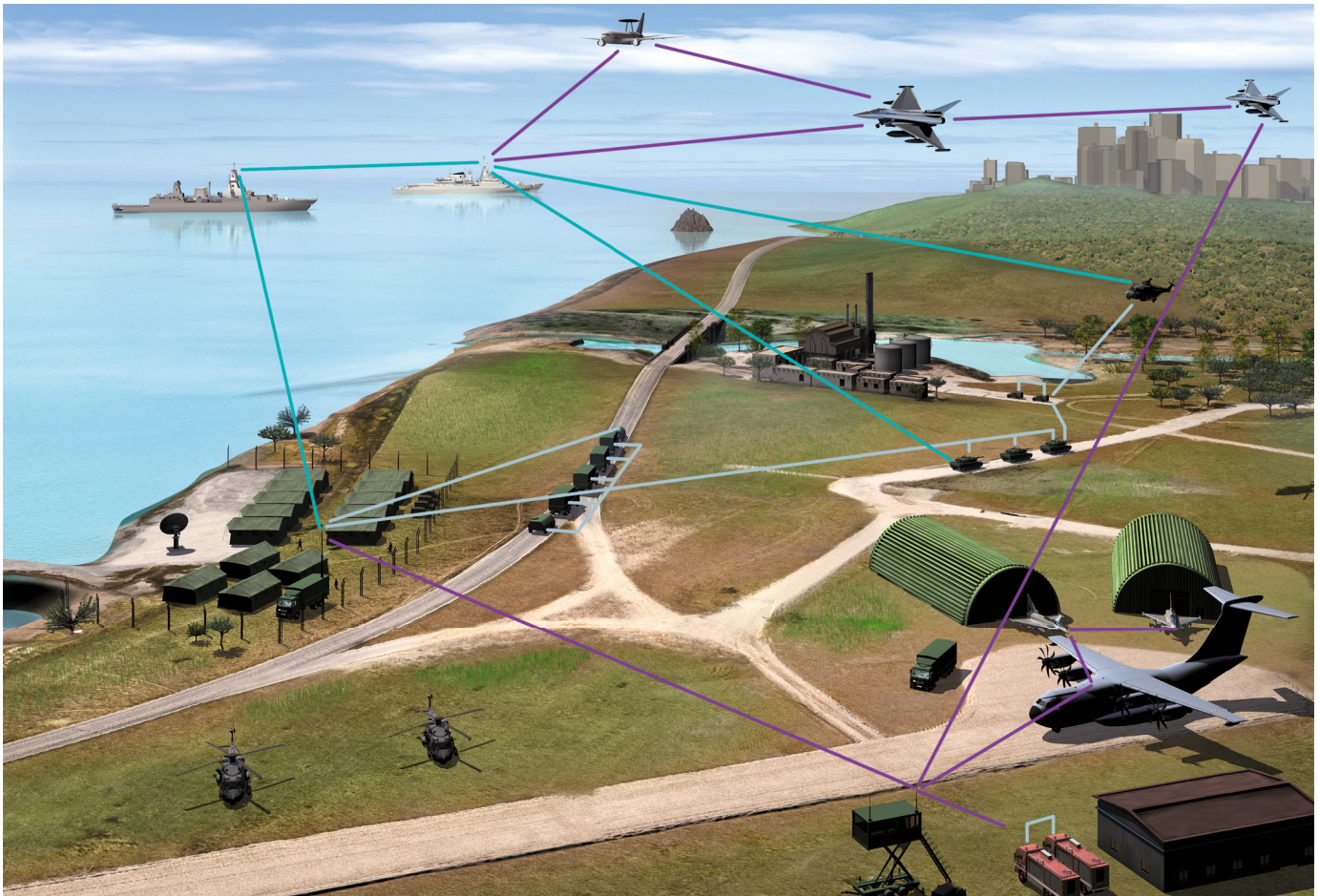

Today's network centric operations require full interoperability between joint and combined forces. Rohde & Schwarz is the world's sole supplier of secure communications solutions for all branches of the armed forces.



# Product overview

Designation	Type
<b>R&amp;S®M3TR radio family</b>	
<b>HF/VHF Tactical Radio, 0.5 W to 10 W (HF up to 20 W)</b>	
Int. GPS receiver, ATU, RS-232-C and IP interface	R&S®MR3000H
Int. GPS receiver, ATU, RS-232-C and IP interface; prepared for HAVE QUICK I/II and/or R&S®SECOS 5/16 TDMA	R&S®MR3001H
Int. GPS receiver, ATU, RS-232-C and IP interface; prepared for HF waveforms	R&S®MR3002H
Int. GPS receiver, ATU, RS-232-C and IP interface; prepared for HAVE QUICK I/II, R&S®SECOS 5/16 TDMA and HF waveforms	R&S®MR3003H
<b>VHF/UHF Tactical Radio, 0.5 W to 10 W</b>	
Int. GPS receiver, RS-232-C and IP interface	R&S®MR3000U
Int. GPS receiver, RS-232-C and IP interface; prepared for HAVE QUICK I/II and/or R&S®SECOS 5/16 TDMA	R&S®MR3001U
Int. GPS receiver, RS-232-C and IP interface; prepared for HF waveforms	R&S®MR3002U
Int. GPS receiver, RS-232-C and IP interface; prepared for HAVE QUICK I/II, R&S®SECOS 5/16 TDMA and HF waveforms	R&S®MR3003U
<b>Tactical handheld transceiver, 0.2 W and 5 W</b>	
Handheld Transceiver	R&S®MR3000P
<b>Mating connector set (R&amp;S®MR300xH/R&amp;S®MR300xU)</b>	
Mating Connector Set	R&S®GK3004
<b>EPM (ECCM) support equipment (R&amp;S®MR300xH/R&amp;S®MR300xU)</b>	
Key Generation Equipment for R&S®SECOM incl. R&S®KGE3000 key generation module	R&S®CP3000
Fillgun for transmitting all relevant preset information as well as COMSEC/TRANSEC keys	R&S®GP3000
Fillgun HAVE QUICK I/II for transmitting all relevant preset information	R&S®GP3100
Key Distribution Device for R&S®SECOS 5/16 TDMA	R&S®KDD3750
<b>Power amplifiers (R&amp;S®MR300xH/R&amp;S®MR300xU)</b>	
500 W HF Power Amplifier for R&S®MR300xH/R&S®MR300xU radios; 1.5 MHz to 30 MHz; standalone	R&S®MG3500
150 W HF Power Amplifier for R&S®MR300xH/R&S®MR300xU radios; 1.5 MHz to 30 MHz	R&S®VK3150
150 W HF Compact Power Amplifier for R&S®MR300xH/R&S®MR300xU radios 1.5 MHz to 30 MHz	R&S®VK3150C
1.5 MHz to 30 MHz; with field telephone and audio/data interface	
50 W VHF/UHF Power Amplifier for R&S®MR300xH/R&S®MR300xU radios; 30 MHz to 512 MHz; with/without co-site filter	R&S®VT3050
50 W VHF/UHF Compact Power Amplifier for R&S®MR300xH/R&S®MR300xU radios 30 MHz to 512 MHz	R&S®VT3050C
30 MHz to 512 MHz; with co-site filter	
30 MHz to 512 MHz; with field telephone and audio/data interface	
30 MHz to 512 MHz; with co-site filter, field telephone, audio/data interface and MIL-STD-188-220C modem	
<b>Batteries and chargers (R&amp;S®MR300xH/R&amp;S®MR300xU)</b>	
Standard Battery Pack, Li-ion, rechargeable; 28.8 V/5.5 Ah	R&S®IB3001
Combat Battery Pack, Li-S02, non-rechargeable; 28 V/7.5 Ah	R&S®IB3002
Battery Charger, AC, stationary; automatic charging of up to eight R&S®IB3001 Li-ion batteries	R&S®IC3000
Battery Charger, DC, mobile; automatic charging of one R&S®IB3001 Li-ion battery	R&S®IC3001
Battery Charger Set; for connection to R&S®IC3001 or R&S®IV3001	R&S®ZR3001
Power supply cables for chargers must be ordered separately	

Designation	Type
<b>Docking stations and accessories (R&amp;S®MR300xH/R&amp;S®MR300xU)</b>	
Single Docking Station with fan; frame only; not operational without additional components	R&S®KG3031
Dual Docking Station with fan; frame only; not operational without additional components	R&S®KG3032
Ground Plate without shockmounts; standard/with slides; for R&S®KG3031/KG3032	R&S®KG3030G
Ground Plate with shockmounts; standard/with slides; for wheeled and tracked vehicles; for R&S®KG3031/KG3032	R&S®KG3032G
Auxiliary Box; standard/field telephone; incl. audio line, Ethernet, audio wideband and multipurpose I/O interface; for R&S®KG3031/KG3032	R&S®GB3130A
Single Remote Control Unit with 3.5/8/12 m connecting cable	R&S®GB3031R
Different RF interfaces and power filter options available on request	
Power Supply Unit/Mounting Frame (different models available)	R&S®IV3001
<b>Mounting Frame with Shockmounts</b>	
For R&S®VT3050 or R&S®VK3150 power amplifier	R&S®KS3000V
For R&S®VT3050C or R&S®VK3150C power amplifier	R&S®KS3001V
For R&S®FK3150 antenna tuning unit	R&S®KS3150F
Blower Unit for R&S®VK3150 or R&S®VT3050 power amplifiers	R&S®KL3000V
<b>Audio accessories (R&amp;S®MR300xH/R&amp;S®MR300xU)</b>	
Handset with PTT microphone and earpiece	R&S®GA3001
Headset with PPT microphone and one/two earpiece(s)	R&S®GA3002
Loudspeaker/Microphone	R&S®GA3003
Loudspeaker for connection to R&S®MR300xH/R&S®MR300xU audio socket with through-connection to R&S®GA3001/GA3002; length of cable: 2/5/10 m	R&S®GA3005
<b>Control cables, data cables, RF cables, power supply cables (R&amp;S®MR300xH/R&amp;S®MR300xU)</b>	
Various cables available on request; must be ordered separately	
<b>Manpack antennas (R&amp;S®MR300xH/R&amp;S®MR300xU)</b>	
Wire Antenna for manpack or stationary use; 1.5 MHz to 30 MHz; 150 W	R&S®AK3001
Wire Dipole Antenna for manpack use; 2 MHz to 90 MHz; 25 W; broadband antenna; with/without mast	R&S®AK3031
Long Wire Antenna; 30 MHz to 88 (108) MHz; 30 W high-gain directional antenna	R&S®HD3001
Hang-Up Antenna; terminated with BNC connector; 30 MHz to 88 MHz; power rating 12.5 W into 50 Ω	R&S®HD3088
GPS Antenna for manpack and vehicle applications; active; magnetic holder; L1 band	R&S®HV3003
Whip Antenna for manpack; 25 MHz to 88 (108) MHz; 20 W	R&S®HV3004
Long Whip Antenna for manpack; 1.5 MHz to 30 MHz; 25 W	R&S®HV3007
Whip Antenna for manpack; 118 MHz to 400 MHz (88 MHz to 450 MHz); 15 W	R&S®HV3009
<b>Vehicular antennas (R&amp;S®MR300xH/R&amp;S®MR300xU)</b>	
HF antenna system for mobile use; 1.5 MHz to 30 MHz; 150 W	R&S®AK503
Whip antenna for vehicle use; 1.5 MHz to 30 MHz; 150 W	R&S®HA104
Whip Antenna for vehicle use; 30 MHz to 108 MHz; 75 W; low profile; with/without GPS base	R&S®HV3012
Whip Antenna for vehicle or stationary use; 225 MHz to 512 MHz; 50 W; center-fed; with/without GPS base	R&S®HV3013
Whip Antenna for vehicle or stationary use; 30 MHz to 108 MHz; 50 W; center-fed; with/without GPS base	R&S®HV3015
Whip Antenna for vehicle or stationary use; 100 MHz to 400 (512) MHz; 50 W; center-fed; with/without GPS base	R&S®HV3019
Broadband vehicle communications antenna 30 MHz to 600 MHz; color: CARC383 (green)	R&S®HK061
<b>Stationary antennas (R&amp;S®MR300xH/R&amp;S®MR300xU)</b>	
Broadband Mobile Antenna; 27.5 MHz to 600 MHz; color: green or sand yellow	R&S®HK055L1
Mast for antennas; 8.5 m height	R&S®KM3031
Mast for antennas; 7 m height	R&S®KM3032
Whip Antenna for stationary use; 225 MHz to 512 MHz; 50 W; center-fed; with mast	R&S®HV3013
Whip Antenna for stationary use; 30 MHz to 108 MHz; 50 W; center-fed; with mast	R&S®HV3015
Whip Antenna for stationary use; 100 MHz to 400 (512) MHz; 50 W; center-fed; with mast	R&S®HV3019
GPS Antenna Supplement for R&S®HK055L1	R&S®KM055
For further antennas, see the "Antennas HF-VHF/UHF-SF" catalog	
<b>Antenna adapters (R&amp;S®MR300xH/R&amp;S®MR300xU)</b>	
Different antenna adapters available on request	
<b>Antenna tuning unit (R&amp;S®MR300xH/R&amp;S®MR300xU)</b>	
Antenna Tuning Unit; 1.5 MHz to 30 MHz; 150 W	R&S®FK3150
Antenna Tuning Unit; 1.5 MHz to 30 MHz; 150 W; with RCB interface; FH capability; color: RAL7001	R&S®FK4115M
Universal RCB Converter	R&S®GH3041

Designation	Type
<b>Rucksacks and manpack bags (R&amp;S®MR300xH/R&amp;S®MR300xU)</b>	
Transport Bag for R&S®KM011 mast; color: olive drab	R&S®MZ3011
Rucksack for R&S®AK3031 antenna; color: camouflage or olive drab	R&S®MZ3031
Rucksack for R&S®MR300xH/R&S®MR300xU and accessories; color: camouflage or olive drab	R&S®MZ3060
Rucksack for R&S®MR300xH/R&S®MR300xU, R&S®XV3088 and accessories; color: camouflage	R&S®MZ3088
Transport Bag for R&S®AK503 antenna, antenna head, radiators and ropes; color: olive drab	R&S®MZ3503
<b>Handheld transceiver and accessories (R&amp;S®MR3000P)</b>	
Tactical Handheld Transceiver, 25 MHz to 146 MHz; 0.2/5 W; including R&S®SECOM-P	R&S®MR3000P
Central Update Tool for R&S®MR3000P radio	R&S®CS3021
Handheld Microphone/Speaker	R&S®GA3023
Serial Data Cable	R&S®GK3028
Power Supply Cable for R&S®IV3021	R&S®GK3029
Fillgun; for transmitting all relevant preset information as well as COMSEC/TRANSEC keys	R&S®GP3021
GPS Receiver	R&S®HV3031
Battery Pack, Li-ion, for R&S®MR3000P radio	R&S®IB3022
Battery Charger, AC, stationary, for R&S®MR3000P radio; automatic charging of up to eight R&S®IB3022 Li-ion batteries	R&S®IC3022
Vehicle charger, DC, for R&S®MR3000P radio	R&S®IC3023
Charger Charger, AC, mobile for R&S®MR3000P radio; automatic charging of one R&S®IB3022 Li-ion battery	R&S®IC3024
Vehicle Support; vehicle mount with charger for R&S®MR3000P radio	R&S®IV3021
Long Tape Antenna for R&S®MR3000P radio; 1.1 m length	R&S®HV3021
Short Tape Antenna for R&S®MR3000P radio; 0.5 m length	R&S®HV3022
Long Tape Antenna, foldable; power rating 5 W at 50 Ω; 1.5 m length	R&S®HV3088L
Bag for R&S®MR3000P radio	R&S®MZ3021
Set Bag for R&S®MR3000P radio and accessories	R&S®MZ3022
Battery Pack Bag for R&S®MR3000P radio	R&S®MZ3023
<b>R&amp;S®RNMS3000 radio network management system</b>	
Mission Planner	R&S®DS3100M
Remote Device Loader	R&S®DS3300D
Remote Distributor	R&S®DS3321D
<b>Test system for radio equipment of the R&amp;S®M3xR family</b>	
Base System; mobile rack version; complete set of radio test equipment including system racks and base software suite	R&S®UCS226XB
M3TR BASE, System Interface Base; radio adaption box and cabling set; including specific radio test software package	R&S®UCS-B20

The radio systems described are hardware- and software-configurable. The system delivered has the configuration as confirmed in the order.

Your local Rohde & Schwarz expert will help you determine the optimum solution for your requirements. To find your nearest Rohde & Schwarz representative, visit [www.sales.rohde-schwarz.com](http://www.sales.rohde-schwarz.com)

## Service you can rely on

- | Worldwide
- | Local and personalized
- | Customized and flexible
- | Uncompromising quality
- | Long-term dependability

## About Rohde & Schwarz

Rohde & Schwarz is an independent group of companies specializing in electronics. It is a leading supplier of solutions in the fields of test and measurement, broadcasting, radiomonitoring and radiolocation, as well as secure communications. Established more than 75 years ago, Rohde & Schwarz has a global presence and a dedicated service network in over 70 countries. Company headquarters are in Munich, Germany.

## Environmental commitment

- | Energy-efficient products
- | Continuous improvement in environmental sustainability
- | ISO 14001-certified environmental management system

Certified Quality System  
**ISO 9001**

Certified Quality System  
**AQAP-2110**

## Rohde & Schwarz GmbH & Co. KG

[www.rohde-schwarz.com](http://www.rohde-schwarz.com)

## Regional contact

- | Europe, Africa, Middle East | +49 89 4129 12345  
[customersupport@rohde-schwarz.com](mailto:customersupport@rohde-schwarz.com)
- | North America | 1 888 TEST RSA (1 888 837 87 72)  
[customer.support@rsa.rohde-schwarz.com](mailto:customer.support@rsa.rohde-schwarz.com)
- | Latin America | +1 410 910 79 88  
[customersupport.la@rohde-schwarz.com](mailto:customersupport.la@rohde-schwarz.com)
- | Asia/Pacific | +65 65 13 04 88  
[customersupport.asia@rohde-schwarz.com](mailto:customersupport.asia@rohde-schwarz.com)
- | China | +86 800 810 8228/+86 400 650 5896  
[customersupport.china@rohde-schwarz.com](mailto:customersupport.china@rohde-schwarz.com)

R&S® is a registered trademark of Rohde & Schwarz GmbH & Co. KG

Trade names are trademarks of the owners

PD 5213.9228.12 | Version 05.00 | August 2013 (ch)

R&S®M3TR

Data without tolerance limits is not binding | Subject to change

© 2008 - 2013 Rohde & Schwarz GmbH & Co. KG | 81671 München, Germany



5213922812